

Operating and Maintenance Manual



24-30-99
Jan 15/2014



SAFT

This document and all information contained herein are the property of Saft. Its use is restricted solely to the maintenance of Saft batteries and may under no circumstances be used for any other manufacturer's products. No person may, in whole or in part, duplicate, use or disclose this information for any other purpose without the prior written consent of Saft.

HISTORY OF REVISION

Date	Modification
Jan 15/2014	Corrections
Aug 23/2013	4078-14, 4078-19, 4417CH14 added
Apr 08/2013	Corrections, 4076-1 added
Oct 12/2012	2371, 2376, 2708-2, 4071, 4071-1, 4076-9 added
Nov 07/2011	4078-11, 4078-12 added
Jul 11/2011	435CH6 added
Mar 04/2011	Corrections
Nov 04/2010	2376-1, 2376-4, 23175, 23176, 4071, 4076, A4078-12 added
Sep 27/2010	Corrections
Jun 03/2010	539CH2, 437CH14, 2778-2 added
Feb 15/2010	272CH1, 40278-14, 345CD1 added
Oct 15/2009	276CH10 added
Aug 07/2009	A275CH1 added, update of flowchart for Periodical Check and General Overhaul
Apr 29/2009	Corrections
Feb 26/2009	23491, 23491-3, 23498-1 added

:

History of revision

HISTORY OF REVISION ----- 1

INTRODUCTION ----- A

1. General	a
2. Website	a
3. Definitions	a
4. Safety	a
4-1. Physical	a
4-2. Electrical	a
4-3. Chemical	b
5. Aircraft Conversions	b
6. Ground Applications	b
7. Placing a new battery in service - initial commissioning	b
8. Battery Ratings	c
8-1. Capacity	c
9. Recycling	d
10. End of life cells	d
11. Measurements	e
11-1. Units of Measure	e
11-2. Measurement Conversion Table	e
11-3. Temperature Conversion Table	f
11-4. Abbreviations	f

DESCRIPTION AND OPERATION ----- 1

1. Description	1
1-1. General	1
1-2. Batteries	1
1-3. Cells	1
1-4. Connectors	3
2. Operation	3
2-1. Temperature	3
2-2. Maintenance	3
2-3. Ventilation	3
3. Charge	3
3-1. Constant Current Charge	3
3-2. Rapid Partial Charge	4
3-3. Constant Potential Charge	5
3-4. Other methods of charging	6

TESTING AND FAULT ISOLATION ----- 1001

1. Introduction	1001
1-1. Battery electrical faults	1001
1-2. Cell faults	1002
1-3. Physical faults	1003

DISASSEMBLY ----- 3001

1. Introduction	3001
2. Safety	3001
3. Equipment	3001
3-1. Standard tools	3001
3-2. Special tools	3001
4. Disassembly procedures	3001
4-1. Removing the cover (010)	3001
4-2. Removing the cells (100)	3001
4-3. Removing the vent valves (160)	3001
4-4. Removing the connector	3001
4-5. Removing the sensor (if applicable)	3001
4-6. Disassembly of the battery	3001

CLEANING ----- 4001

1. Introduction	4001
2. Safety	4001
3. Equipment	4001

- 3-1. Standard tools -----4001
- 3-2. Special tools -----4001
- 3-3. Consumables -----4001
- 4. Light Cleaning -----4001
 - 4-1. Procedure -----4001
- 5. Thorough Cleaning -----4001
 - 5-1. Procedure -----4001
- 6. Lubrication -----4002

INSPECTION/CHECK ----- 5001

- 1. Introduction -----5001
 - 1-1. General -----5001
- 2. Safety -----5001
- 3. Equipment -----5001
 - 3-1. Standard tools -----5001
 - 3-2. Special tools -----5001
- 4. Maintenance intervals -----5001
 - 4-1. Periodical check -----5001
 - 4-2. Regular check -----5001
 - 4-3. General overhaul -----5001
- 5. Recording -----5001
- 6. Periodical check -----5002
 - 6-1. Visual Inspection -----5002
 - 6-2. Insulation check -----5003
 - 6-3. Nut tightness -----5004
 - 6-4. Polarization test -----5004
 - 6-5. Residual discharge -----5004
 - 6-6. Adjust electrolyte level -----5004
 - 6-7. Supplementary test -----5005
- 7. Regular check -----5006
 - 7-1. Cell shorting -----5007
 - 7-2. Capacity check -----5007
- 8. General overhaul -----5008
 - 8-1. Component inspection -----5009
 - 8-2. Replacement of faulty components -----5009
 - 8-3. Sensor check -----5009
 - 8-4. Vent valve test -----5015
- 9. Return to Service After Storage -----5015

ASSEMBLY ----- 7001

- 1. Introduction -----7001
- 2. Safety -----7001
- 3. Equipment -----7001
 - 3-1. Standard tools -----7001
 - 3-2. Special tools -----7001
- 4. Battery Assembly -----7001
 - 4-1. Installation of the vent valve (160) -----7001
 - 4-2. Assembly of the battery -----7001
 - 4-3. Fill in -----7001

FITS AND CLEARANCES ----- 8001

- 1. Introduction -----8001
- 2. Specification table -----8001

SPECIAL TOOLS, FIXTURES, EQUIPMENT AND CONSUMABLES -- 9001

- 1. Introduction -----9001
- 2. Standard tools -----9001
- 3. Special tools -----9002
 - 3-1. Tool kit -----9005
- 4. Consumables -----9006

----- ILLUSTRATED PARTS LIST 10001

- 1. Detailed part list -----10001
- 2. Battery part list -----10003

3. Links part list	10008
3-1. List	10008
3-2. Drawings	10013
4. Cell part list	10018

STORAGE (INCLUDING TRANSPORTATION) ----- 15001

1. Introduction	15001
1-1. General	15001
1-2. Storage room	15001
1-3. Temperature conditions	15001
2. Inactive long term storage	15001
3. Inactive stand-by storage	15001
3-1. Ambient temperature lower than or equal to 20 °C (68 °F)	15002
3-2. Ambient temperature greater than 20 °C (68 °F)	15002
3-3. Ambient temperature greater than 20 °C (68 °F) with 'topping' or 'refresh charge'	15002
3-4. Action at the end of the stand-by period	15002
4. Active stand-by mode (= use of a trickle charge)	15002
5. Spares	15002
5-1. Spare Cells	15002
5-2. Spare O-rings, gaskets and vent valves	15003
5-3. Other spares	15003
6. Servicing after discharged storage	15003
7. Transportation procedure	15003

PAGE INTENTIONALLY LEFT BLANK

INTRODUCTION

1. General

This manual provides the information necessary for an experienced shop technician to maintain Saft nickel-cadmium batteries. It describes construction of the battery, as well as techniques used to operate, maintain, repair, overhaul, and generally care for the battery. Following these instructions will enhance the ability to obtain optimum performance and maximum life from Saft batteries. Saft offers training classes that will assist in the optimization of battery life and the lowest possible maintenance costs. Contact your preferred Saft representative for further details.

All aircraft batteries require checking and maintenance in order to make sure they are safe when installed and they perform their required functions especially in emergency conditions on board the aircraft. Maintenance checks also permit any problems to be identified and corrected. The maintenance interval is the period for which correct operation is assured with a low probability of failure and allows high levels of MTBUR and MTBF to be achieved. Apart from the question of safety, the avoidance of failure on board the aircraft, with consequent costly impact on delays, reduces operational costs.

NOTE: Some Saft batteries have a specific Component Maintenance Manual (CMM) assigned to them. If a CMM exists, that information will supersede the contents of this manual for that particular battery type and this document will become supplemental. Contact a Saft representative, or check the Saft website at www.saftbatteries.com/cmm/, for a complete listing of available Component Maintenance Manuals.

Every effort has been made to provide complete and accurate instructions. If a situation should arise that is not adequately described in this manual, please contact Saft via the internet at www.saftbatteries.com or at one of the following addresses :

Saft America Inc. (V09052)
711 Industrial Boulevard
Valdosta, Georgia 31601 - USA
Tel: +1 (229) 247-2331
Fax: +1 (229) 247-8486

Saft (F6177)
12, rue Sadi Carnot
93170 Bagnolet - France
Tel: +33 (0) 1 49 93 19 18
Fax: +33 (0) 1 49 93 19 56

Saft manufactures a wide range of batteries for aircraft applications. These batteries vary in size, weight, capacity and/or electrical performance to fit the specific requirements of the application. The Specification tables in [FITS AND CLEARANCES](#) chapter list the basic specifications for the Saft batteries covered by this manual. For information on Saft batteries not listed here, contact your local Saft representative.

2. Website

All Saft technical documentation, distributors and repair shops can be found on www.saftbatteries.com.

3. Definitions

Warnings call attention to use of materials, procedures, or limits, which must be followed precisely to avoid injury to persons.

Cautions call attention to procedures which must be followed to avoid damage to equipment.

Notes call attention to procedures which make the job easier.

4. Safety

⚠ Except for those steps that require the battery to be charged, do all steps on discharged batteries (refer to [Residual discharge](#) paragraph) to avoid the possibility of electric shock. Tighten vent-valves (160) prior to beginning discharge. Battery cells deliver very high current when short-circuited. Exercise caution. Remove rings, watches, necklaces, metallic belts or other jewelry to avoid electric shock.

⚠ Do not tilt the battery while doing maintenance, any contact of skin with electrolyte can cause severe burns.

Safety rules are different from one country to another. Always follow local safety regulations.

There are three types of risks.

4-1. Physical

- Handling: the battery is heavy. When you lift it, bend your legs and not your back.
- Use protective shoes.

4-2. Electrical

- Do not wear rings, watches, chains, belt buckles, necklaces or any other metallic objects.

INTRODUCTION

- Use insulated tools.

4-3. Chemical

For a complete listing of hazards, refer to the MSDS available on Saft's website at www.saftbatteries.com

- Electrolyte is very corrosive and can damage the skin: use gloves and an apron. If it touches the skin, flush affected part with water and neutralize with an acetic solution, vinegar or lemon juice, or with a boric acid solution at 10% concentration.
- Electrolyte is very dangerous for eyes, use protective goggles. If the electrolyte comes in contact with the eyes, flush them with water for at least 15 minutes and immediately call a doctor.
- Electrolyte ingestion can cause damage to the throat and the respiratory tract. Do not try to vomit. Call a doctor immediately.
- Skin contact with nickel can cause chronic eczema.
- Inhalation of cadmium oxide can cause dry throat, headaches, vomiting, chest pain. If inhaled, remove to fresh air. If not breathing, give artificial respiration. If breathing is difficult, give oxygen. Get medical attention immediately.
- Potassium hydroxide in the electrolyte can cause eczema.

5. Aircraft Conversions

Saft aircraft batteries come in a wide variety of configurations that are approved for installation on selected aircraft. When replacing a lead-acid battery with a Saft nickel-cadmium aircraft battery, it is vitally important to clean all mounting and holding fixtures in the aircraft prior to installation. All traces of acid and salt should be removed by washing with a neutralizing agent such as sodium bicarbonate (baking soda) in water. Once the area has been fully cleaned and prepared, the surface should be painted with an alkaline resistant paint. This preparation should ensure that your new Saft battery will not be harmed by sulfuric acid residue.

6. Ground Applications

Your Saft battery can be used in such ground applications as starting gas turbine generators, ground mobile equipment, or in shop testing equipment. The same principles used in flight operations apply when the battery is used in ground applications. Ventilation of the battery during ground use can be accomplished through a ventilation system or by simply removing the cover (only in a well-ventilated area). Check with your local authorities for regulations in effect for your area.

7. Placing a new battery in service - initial commissioning

NOTE: Whether or not the battery has been subject to disassembly and reassembly, before its issue to service and installation, the tightness of all connector nuts / screws must be checked to verify that torque values correspond with those specified.

Saft batteries are shipped discharged. A visual inspection, torque check, charge procedure, electrolyte check, and insulation test should be done prior to the battery being placed into the aircraft for service. Refer to the [INSPECTION/CHECK](#) chapter.

If the battery has been stored for longer than 3 months, refer to [Servicing after discharged storage](#)

8. Battery Ratings

8-1. Capacity

Nickel-cadmium batteries are rated in terms of capacity in ampere-hours (Ah) (rated capacity).

American Standard AS8033 defines capacity as "the dischargeable ampere-hours (Ah) available from a fully charged cell/battery at any specified discharge rate/temperature condition".

Other definitions for battery ratings can be found in EN2570, IEC 60952 and RTCA DO 293.

A battery rated for 1C₁ Ah indicates that the battery is rated at a value based upon a discharge time of 1 hour at 23°C ± 3°C (73.4°F ± 5.4°F). In other words, a battery with a rated capacity of 40 Ah (1C₁ Ah) will deliver no less than 40 A for one hour when new.

A typical discharge curve for Saft VHP series cells can be found in Figure 1.

Type VHP cells (20 cells)

On-load terminal voltage vs capacity discharged for various discharge current at 23°C (73.5°F) 1C₁A and 10C₁A

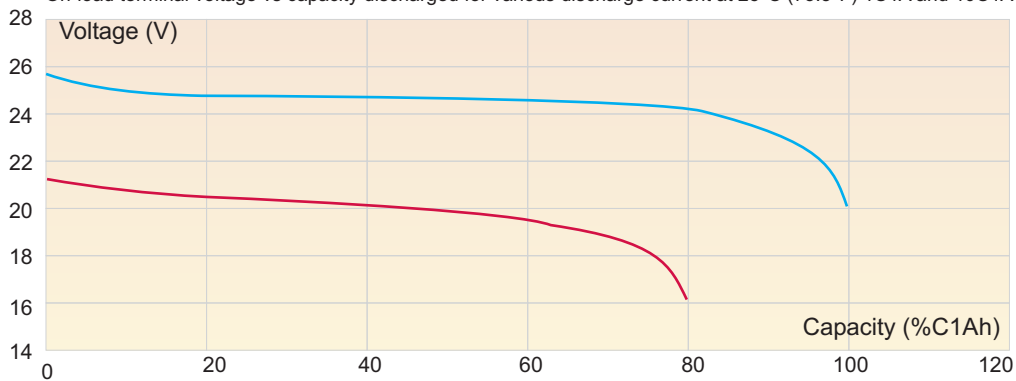

Discharge Curve for VHP Series Cell
Figure 1

9. Recycling

All batteries eventually lose their ability to perform and are eligible for scrap and recycling. Saft takes environmental matters seriously and advocates proper recycling of nickel-cadmium batteries and their components. To that end, Saft operates recycling facilities in both Europe and North America.

Nickel-cadmium batteries contain nickel, cadmium, and potassium hydroxide and should be disposed of properly. In all cases, rely on local and national regulations for proper battery disposal and/or shipping to an appropriate recycling location.



Universal Recycling Symbols
Figure 2

You can find the nearest recycling collection point on our website www.saftbatteries.com.

10. End of life cells

EASA regulations 'Part 145', require that end of life cells must be disposed of in a manner that does not allow them to be returned to service. The following procedure provides a means of complying with these regulations. While other authority requirements (such as FAA) may be less explicit, Saft recommends that the following procedures be adopted.

In order to ensure that end of life cells cannot be re-used, the following procedure is recommended:

- Ensure that appropriate protective measures (refer to [Safety](#) paragraph) and MSDS are taken.
- Ensure that the cell is fully discharged (refer to [Cell shorting](#) paragraph)
- Put one of the terminals from the cell between the two sides of a bench vice and bend until the terminal breaks. In the event of electrolyte leakage, ensure that appropriate clean up measures as described in the MSDS are observed.
- Dispose of the cell in accordance with applicable transport, health and safety and recycling regulations (Refer to [Recycling](#) paragraph).

11. Measurements

The measurements which are given in this manual come from the original manufacturing drawings.

This OMM uses the "Système International" (S.I.) units for quantities and values. It also gives the imperial units in parentheses.

11-1. Units of Measure

11-1-1. I.S. Units

A	Ampere
Ah	Ampere hours
C ₁ A	Rated current
C ₁ Ah	Rated capacity for an hour
g	Gram
min	Minute
N	Newton
N.m	Newton meter
Pa	Pascal
V _{DC}	Volt direct current
°C	Degree Celsius
%	Per cent
Ω	Ohm

11-1-2. U.S. Units

ft	Foot
in	Inch
inHg	Inch of mercury
lb	Pound
lbf.in	Pound force inch
°F	Degree Fahrenheit

11-1-3. Multiplying Prefixes

μ	Micro
m	Milli
da	Deca
k	Kilo
M	Mega

11-2. Measurement Conversion Table

11-2-1. From U.S. Standard System to I.S. Measurement

1 kPa	0.1450 psi
1 cm	0.3937 in
1 cm ²	0.1550 in ²
1 N	0.2248 lbf
1 g	0.0353 oz
1 kg	2.2046 lb
1 mm	0.0394 in
1 N.m	8.8507 lbf/in

INTRODUCTION

11-2-2. From U.S. Standard System to I.S. Measurement

1 psi	6,8948 kPa
1 in	2,54 cm
1 in	25,4 mm
1 in ²	6,4516 cm ²
1 lbf	4,4482 N
1 oz	28,3495 g
1 inHg	3,3864 kPa
1 lb	0,4536 kg
1 gal (U.S.)	3,7854 l/min
1 lbf.in	0,1130 N.m
1 lbf.ft	1,3558 N.m

11-3. Temperature Conversion Table**11-3-1. SI MEASUREMENT Degrees Celsius (°C)**

$$\text{Celsius} = (\text{Fahrenheit} - 32) \times 0.5555$$

11-3-2. U.S. STANDARD SYSTEM Degrees Fahrenheit (°F)

$$\text{Fahrenheit} = (\text{Celsius} \times 1.8) + 32$$

11-4. Abbreviations

The abbreviations given below are used in this manual:

AECMA	European Association of Aerospace Industries
ATA	Air Transport Association of America
EASA	European Aviation Safety Agency
FAA	Federal Aviation Administration
dia.	diameter
fig.	figure
ipl	illustrated parts list
max.	maximum
mfr	manufacturer
min.	minimum
n°	number
p/n	part number
para.	paragraph
ref.	refer to
s/a	subassembly
TBD	to be defined
V	Voltage

DESCRIPTION AND OPERATION

1. Description

1-1. General

The batteries are connected to the aircraft system:

- According to the aircraft manufacturer, to start the engine or the APU.
- On the ground, to provide power before electrical power is supplied to the aircraft systems.
- In flight, if a malfunction or a failure occurs in the power supply system.

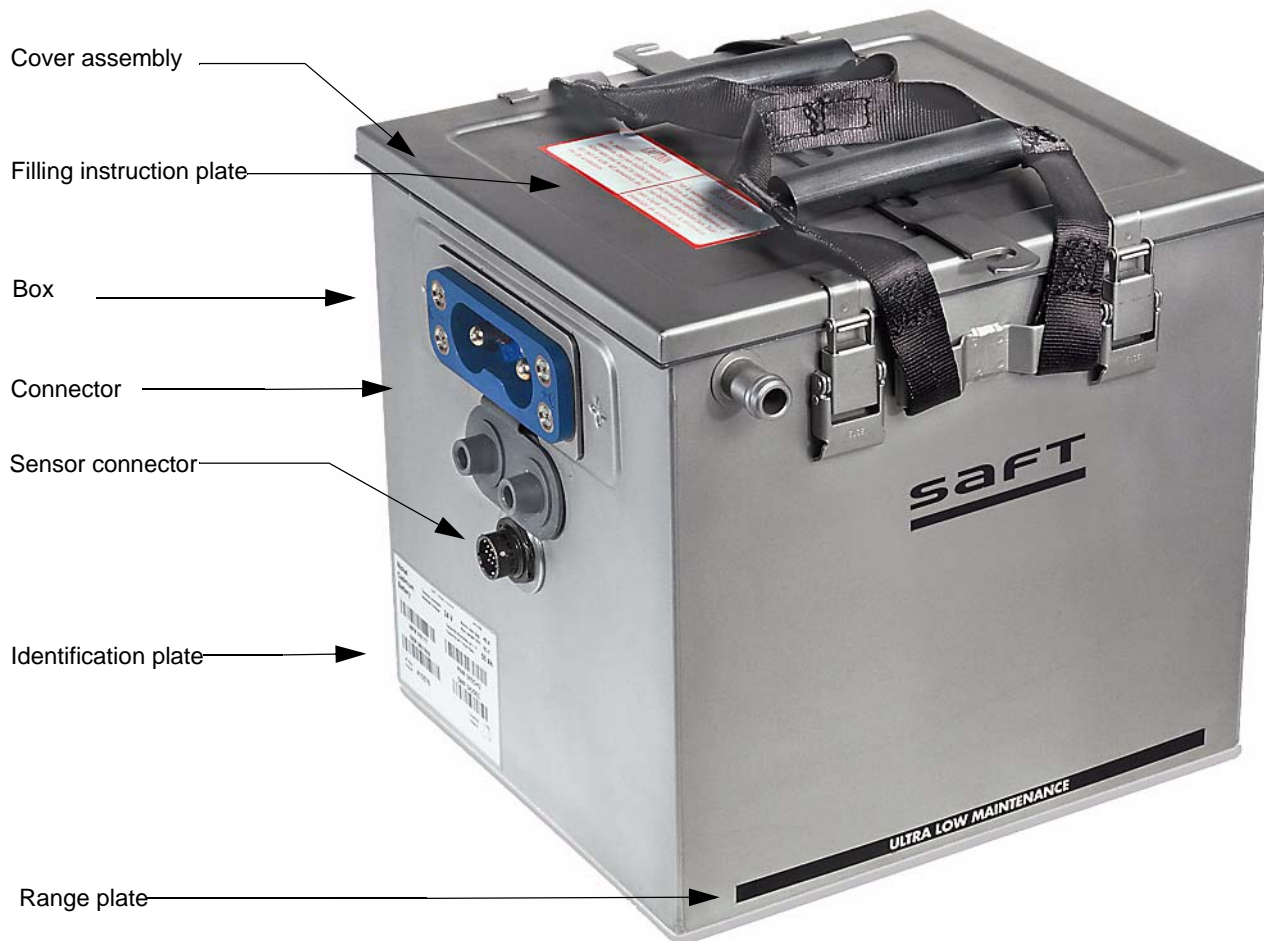

Nickel-Cadmium Aircraft Battery

1-2. Batteries

NOTE:The item numbers are those of the detailed parts list chapter.

Each Saft nickel-cadmium battery consists of a metallic box (020), usually stainless steel, plastic-coated steel, painted steel or titanium, containing a number of individual cells. These cells are connected in series to obtain a specified voltage, usually 12 or 24 volts nominal. Individual cells are enclosed in a polyamide container that provides insulation, allowing them to be fitted side-by-side in the battery box. Interconnection of cells is via rigid, highly conductive, nickel-plated copper links(030). Each link is held in place by nickel-plated copper nuts (110) on the cells' terminals (or nickel-plated steel screws for internally threaded terminals). Inside the battery box, individual cells are held in place by partitions, liners and spacers (200), and a cover assembly (010). Each battery is designed with appropriate ventilation to allow the escape of gases produced during an overcharge condition and to provide cooling during normal operation.

1-3. Cells

The cell is the active component of the battery. It is here that the electrochemical reaction takes place converting chemical energy into electricity. In Saft aviation batteries, the design features are on the cutting edge of today's technology.

DESCRIPTION AND OPERATION

The active elements of the nickel-cadmium cell are either two groups of thin, porous, sintered nickel plates (VO, VP, VXP & Delta Plus (VHP) Series) or one group of positive sintered nickel plates and one group of negative Plastic Bonded Electrode (PBE) plates [ULM[®] Series (CVH, CVK, CVD)]. In all cells, the positive plates are sintered nickel, impregnated with nickel-hydroxide. The negative plates are either sintered nickel impregnated with cadmium-hydroxide, or cadmium-oxide applied in a non-sintered coating process (PBE), which is later converted to cadmium-hydroxide during manufacturing. In the cell, the positive and negative plates are immersed in electrolyte, a solution of potassium hydroxide and water.

Within the cell container, a three-part separator separates the plates of opposite polarity. The outer layers are a felt-like fabric. This fabric allows the electrolyte to stay in contact with the plates by "wicking". The inner layer is either an organic or a micro-porous synthetic material that acts as a gas barrier to control oxygen recombination during recharge.

Each set of positive and negative plates is connected to a plate tab that employs a continuous welding joint for maximum energy transfer. These terminals are connected to the respective terminal posts. The terminal post is what allows external connections to be made. An O-ring seals the terminals.

Each cell is equipped with a vent-valve that can be removed to allow access to the electrolyte (for the addition of distilled or deionized water). This valve also serves as a pressure-checking device, designed to limit the pressure inside the cell to 0.7 bar (10 psi) maximum.

Many cells have a raised edge surrounding the vent-valve to contain any minor release of electrolyte that may occur during overcharge.

Saft cells are composed of a cover and body made of polyamide plastic. These are thermally welded together to form a single, leak proof container. This ensures that if the battery is maintained and used under normal circumstances, it will never leak.



Cutaway of a Vented Cell
Figure 1

1-4. Connectors

Each Saft battery is connected to the aircraft by either a standard main power connector, such as an MS3509 type, or a special connector as specified by the aircraft manufacturer. Refer to "[FITS AND CLEARANCES](#)" to determine the connector used on the batteries covered by this manual.



Connectors
Figure 2

2. Operation

2-1. Temperature

Although Saft nickel-cadmium batteries are capable of operating in a wide temperature range [-40°C (-40°F) to +71°C (+160°F)], optimum performance is obtained between +5°C (+41°F) and +45°C(+113°F). Charging is inefficient at temperatures below -30°C (-22°F) and is not recommended above 57°C (135°F). Charging must be stopped at temperatures above +71°C (+160°F).

Unless otherwise stated, charge and discharge testing should be done when the battery temperature is between +15°C and + 30°C.

2-2. Maintenance

All maintenance, including charging, discharging, should be done specifically in accordance with the instructions contained in this manual or a corresponding Component Maintenance Manual (CMM). If a CMM exists for a battery, that information will supersede the contents of this manual and this OMM will become supplemental.

2-3. Ventilation

Battery ventilation and cooling is accomplished through two methods. Most Saft batteries are equipped with tubes designed for the connection of a battery venting system. In others, holes in the battery box allow for heat dissipation and ventilation of any hydrogen produced.

3. Charge

3-1. Constant Current Charge

Starting with a discharged battery.

- Remove the cover assembly ([010](#)).
- Loosen, but do not remove, all vent-valves ([160](#)).

DESCRIPTION AND OPERATION

- Charge using one of the methods shown in the table below.

NOTE: Check cell voltage at the beginning of the charge. If any cell indicates an immediate voltage rise above 1.5 V, add 5 cm³ of distilled or deionized water to that cell.

- During the last 15-30 minutes of the overcharge cycle, [Adjust electrolyte level](#).

Main charge			Final charge (overcharge)		
Current and duration			Minimum voltage	Current and duration	Minimum voltage at the end of charge
0.1 C ₁ A	time	mini 10 h maxi 12 h	1.5 V/cell	0.1 C ₁ A for 4 h	1.5 V/cell for VO/VP/VHP/VXP 1.55 V/cell for CVH/CVD/CVK
0.5 C ₁ A	time	mini 2 h maxi 2 h 30 min.	1.55 V/cell	0.1 C ₁ A for 4 h	1.5 V/cell for VO/VP/VHP/VXP 1.55 V/cell for CVH/CVD/CVK
1 C ₁ A	time	mini 1 h maxi 1 h 15 min.	1.57 V/cell	0.1 C ₁ A for 4 h	1.5 V/cell for VO/VP/VHP/VXP 1.55 V/cell for CVH/CVD/CVK

Table 1 - Charge Rates

3-2. Rapid Partial Charge

One of the following two procedures can be used in an emergency situation to charge the battery to approximately 80% of its capacity. **Do not use these procedures for charging the battery during normal maintenance.**

- Charge the battery at 0.5C₁A until the battery reaches an average of 1.55 V/cell. Do not charge for more than 2 hours and 30 minutes
- Charge the battery at 1C₁A until the battery reaches an average voltage of 1.57 V/cell. Do not charge for more than 1 hour and 15 minutes.

3-3. Constant Potential Charge

⚠ Constant potential charging should not be attempted if the open circuit battery voltage is below 1.0 V per cell.

In an emergency, a partially discharged battery may be recharged using a constant potential charging system such as exists on the aircraft. Do not use this procedure for charging the battery during normal maintenance:

With the use of a constant potential system, it is imperative that the charge rate be checked periodically for accuracy, and that the charger be set according to the average ambient operating temperature. The figures below can be used as a guide to ensure the correct charge rate used for a given ambient temperature.

NOTE: A maintenance check of the battery should be done at the earliest opportunity to verify battery performance.

Connect the battery to the constant potential power source. Charge for a minimum of 1 hour at 1.425 V/cell to obtain approximately 90% of the rated capacity of the battery..

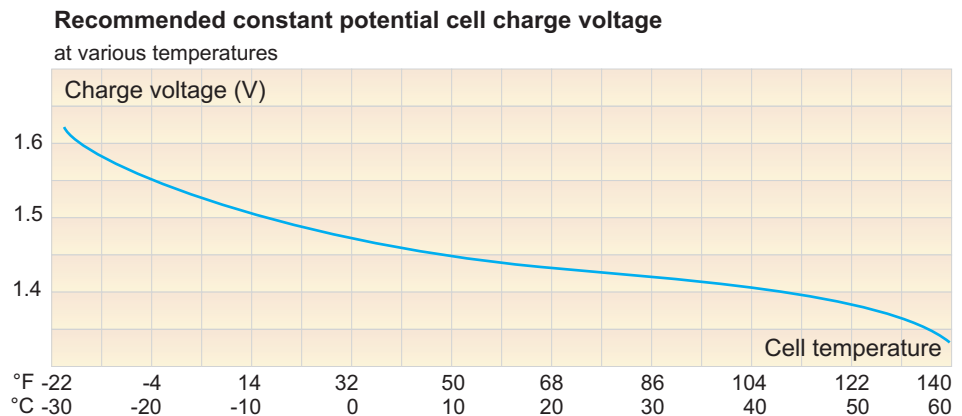

Recommended Constant Potential Cell Charge Voltage

Figure 3

This figure shows the typical charge curves for Saft nickel-cadmium aviation batteries.

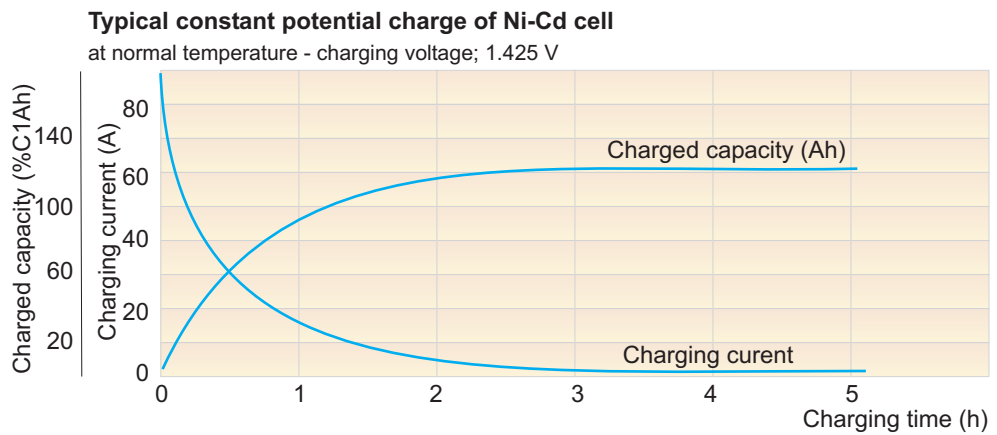

Typical Constant Potential Charge Curve

Figure 4

NOTE: A maintenance check of the battery should be done at the earliest opportunity to verify battery performance.

3-4. Other methods of charging

In addition to the constant current method of charging, other methods that fully charge the battery can be used. **However, in any case, cell voltage checks ($U > 1.50$ V for VO,VP, VHP, VXP and $U > 1.55$ V for CVH) and electrolyte adjustments must be carried out using a final overcharge sequence at constant current $0.1 C1A$ during 4 hours.** If specific instructions are not given in the charger operating manual, you must first contact Saft.

TESTING AND FAULT ISOLATION

1. Introduction

This chapter gives the tests and inspections required to find the cause of a fault condition of the unit either removed for unscheduled maintenance or during scheduled maintenance. The test procedure is given in the tables below. For each test refer to the indicated procedures which specify all necessary information.

1-1. Battery electrical faults

Problem	Probable cause	Correction
(1) Zero battery open-circuit voltage	(a) Defective electrical connector (no contact made) (b) Link broken	Check electrical contacts, links and tightness of nuts (refer to INSPECTION/CHECK).
(2) Zero volt with the battery set to "discharge"	(a) Battery fully discharged (b) Battery circuit open or contacts defective (c) Cell completely dry	Charge the battery. Do an insulation check (refer to INSPECTION/CHECK) Examine the contacts and links. Make sure the terminal nuts are tight (refer to INSPECTION/CHECK). Refer to related subsequent steps.
(3) Low insulation	(a) Leakage of electrolyte	Disassemble and clean the battery (refer to DISASSEMBLY and CLEANING). Do an electrolyte level check (refer to INSPECTION/CHECK).

Table 1 - Battery electrical faults

TESTING AND FAULT ISOLATION

1-2. Cell faults

Problem	Probable cause	Correction
(1) Too much water decrease for all battery cells.	(a) Charge much more than the limit or too much charge at high temperature.	Examine the cause of excessive charge. If necessary, adjust to normal operating temperature (refer to DESCRIPTION AND OPERATION).
(2) Water decrease in cell(s) is very different from the other cells in the battery.	(a) More than 30% or more than the average : cell leakage. (b) 30% (or less) of the average: cell(s) with damaged separator(s). (c) Previous maintenance has not been done.	Check for cell leakage (refer to INSPECTION/CHECK). Do the Supplementary test (refer to INSPECTION/CHECK). If necessary, replace the cell(s). Note the cell location and check the level of water consumption versus other cells at the next maintenance.
(3) A cell has higher voltage at the start of charge than is defined in para. Charge chapter DESCRIPTION AND OPERATION .	(a) Dry cell.	When the defect occurs, add 5 cm ³ (5 ml) of distilled water to the cell. Do not adjust more accurately until the end of the charge.
NOTE: If you charge a cell with a quantity of electrolyte which is not sufficient, this can cause temperature to increase too much.		
(4) A cell has a lower voltage at the end of charge than is defined in para. Charge chapter DESCRIPTION AND OPERATION .	(a) The cell was operated at temperatures and charge rates outside the limits, and the separator is damaged. (b) Usual wear after long operation	Replace the cell (refer to DISASSEMBLY, ASSEMBLY AND Storage (including transportation)).
(5) Low capacity cell.	(a) insufficient balancing (b) Usual wear after long operation. (c) Unusual operation, operation at high temperature or operation with low electrolyte.	Repeat Charge , discharge at 1 C ₁ AH and Cell shorting up to three times Replace the cell (refer to DISASSEMBLY, ASSEMBLY AND Storage (including transportation)). Do the applicable procedure (refer to INSPECTION/CHECK).
(6) Cell with a swollen case	(a) Cell operated with low electrolyte level ; deterioration of separators and damaged plates.	Replace the cell (refer to DISASSEMBLY).
(7) Cell with zero voltage when the battery circuit is open.	(a) Short-circuited cell.	Replace the cell (refer to DISASSEMBLY).

Table 2 - Cell faults

1-3. Physical faults

Problem	Probable cause	Correction
(1) Leakage of electrolyte	<p>(a) Incorrect adjustment of electrolyte level.</p> <p>(b) Cell polarity incorrect during high-rate discharge (for example, during the engine start).</p> <p>(c) Too much charge at high temperature or too much current.</p> <p>(d) The lower nut is not correctly tightened .</p>	<p>Disassemble and clean the battery (refer to DIS-ASSEMBLY and CLEANING chapters). Do an electrolyte level check (refer to INSPECTION/CHECK).</p> <p>Disassemble and clean the battery (refer to DIS-ASSEMBLY and CLEANING). Do an electrolyte level check (refer to INSPECTION/CHECK).</p> <p>Investigate the cause of excessive charge. If necessary, adjust to normal operating temperature (refer to DESCRIPTION AND OPERATION). Disassemble and clean the battery (refer to DIS-ASSEMBLY and CLEANING).</p> <p>Do an electrolyte level check (refer to INSPECTION/CHECK). Torque the lower nut (refer to ASSEMBLY chapter)</p>
(2) Electrolyte found in the battery box.	<p>(a) Damaged cell case</p> <p>(b) Leakage of electrolyte</p>	<p>Do a leak test of the cells (refer to INSPECTION/CHECK). Replace the cell if necessary and refer to related subsequent steps.</p> <p>Disassemble and clean the battery (refer to INSPECTION/CHECK and CLEANING). Do an electrolyte level check (refer to INSPECTION/CHECK).</p>
(3) Corrosion on the links.	<p>(a) Operation in acidic air</p> <p>(b) Mechanical damage to nickel plating</p>	<p>Make sure the battery test bench and the storage areas have no materials which can give off acid fumes.</p> <p>Replace the damaged links (refer to DISASSEMBLY, ASSEMBLY AND Storage (including transportation)).</p>
(4) The links are too hot.	<p>(a) Loose terminals nuts.</p>	<p>Make sure the nuts are torqued (refer to INSPECTION/CHECK).</p>

Table 3 - Physical faults

PAGE INTENTIONALLY LEFT BLANK

DISASSEMBLY

1. Introduction

NOTE: Refer to the [TESTING AND FAULT ISOLATION](#) chapter to identify the possible cause of a malfunction. This will give the necessary level of disassembly.

The instructions found in this section are designed to allow the maintenance person to completely disassemble the battery for the purpose of General Overhaul. However, some maintenance operations do not require complete disassembly. Disassemble only to the extent necessary to effect appropriate repair or replacement.

2. Safety

Refer to chapter [Standard tools](#) in [SPECIAL TOOLS, FIXTURES, EQUIPMENT AND CONSUMABLES](#).

3. Equipment

3-1. Standard tools

Refer to chapter [Standard tools](#) in [SPECIAL TOOLS, FIXTURES, EQUIPMENT AND CONSUMABLES](#).

3-2. Special tools

When special tools are used in this chapter, they are identified by a code number listed in [SPECIAL TOOLS, FIXTURES, EQUIPMENT AND CONSUMABLES](#) chapter.

4. Disassembly procedures

NOTE: All () part identification numbers herein are IPL Fig. 1 item numbers and are using hypertext facility.

4-1. Removing the cover (010)

Depending on the type of cover, undo the retaining latches or the retaining screws. Remove the cover taking care to avoid contact between the cover and the cell terminals or links.

4-2. Removing the cells (100)

NOTE: Make note of the proper placement of the links (030 to 090) prior to removal. To facilitate ease of removal, remove the center cell in each row first.

Remove the nuts (110) and the spring (120) washers that attaches links to the cells.

Cut cable grip if applicable.

Remove all links (030 to 090).

Fully screw the extractor tool onto a cell terminal then pull up to remove the cell (100).

4-3. Removing the vent valves (160)

Unscrew the vent valve with the special tool.

Remove the vent valve (160) with its O-ring.

4-4. Removing the connector

Remove the screws (210) and the washers (220).

Remove the connector (230).

4-5. Removing the sensor (if applicable)

NOTE: Note the sensor installation before removing.

Unscrew the sensor from the links (030 to 090).

Depending on the type of sensor, undo the retaining nut or the retaining screws. Remove the connector and the sensor harness taking care to avoid damaging the cabling.

Push the connector through the hole in the battery box (020).

4-6. Disassembly of the battery

Remove the cover (010).

Remove the cells (100).

DISASSEMBLY

Remove the liner spacer kit ([200](#)). Note placement prior to removal to ensure proper placement during re-assembly.

Remove the connector ([230](#)).

Remove the sensor (if applicable).

CLEANING

1. Introduction

The instructions in this chapter are for the general cleaning of your Saft aircraft battery. The instructions under "Light Cleaning" are to be done each time the battery is removed from the aircraft, and can be accomplished with no disassembly of the battery. The section "Thorough Cleaning" includes the instructions for the cleaning of a disassembled battery for the purpose of General Overhaul.

2. Safety

Refer to chapter [Standard tools](#) in [SPECIAL TOOLS, FIXTURES, EQUIPMENT AND CONSUMABLES](#).

3. Equipment

3-1. Standard tools

Refer to chapter [Standard tools](#) in [SPECIAL TOOLS, FIXTURES, EQUIPMENT AND CONSUMABLES](#).

3-2. Special tools

When special tools are used in this chapter, they are identified by a code number listed in [SPECIAL TOOLS, FIXTURES, EQUIPMENT AND CONSUMABLES](#) chapter.

3-3. Consumables

When consumables are used in this chapter, they are identified by a code number listed in [SPECIAL TOOLS, FIXTURES, EQUIPMENT AND CONSUMABLES](#) chapter.

4. Light Cleaning

On an assembled battery.

⚠ Do not use solvent, petroleum spirits, trichlorethylene or other products containing chloride for cleaning the battery. The use of solvents may degrade the integrity of metal and plastic parts.

NOTE: All () part identification numbers herein are IPL Fig. 1 item numbers.

4-1. Procedure

⚠ To prevent injury when using compressed air, direct air stream away from the body. Use safety goggles to prevent eye injury from airborne particles.

- Remove the battery cover assembly (010).
- Check the battery vent tubes to ensure that they are clean and clear.
- Tighten the vent valves (160) with the Universal vent wrench (T01)
- Remove potassium carbonates (white deposits) from the top of all cells (100) using a stiff bristle, non-metallic brush.
- Disperse residual salts and dust particles from the battery using blasts of clean, dry compressed air.
- Coat all upper nuts (or screws) (110) and links (030 to 090) with M02.

5. Thorough Cleaning

On a disassembled battery.

5-1. Procedure

Fully disassemble the battery (refer to [DISASSEMBLY](#) chapter).

5-1-1. Cells (100)

Make sure that the vent valve (160) is tight.

⚠ Do not soak the cells in water.

To easily remove all the electrolyte and mineral salts from the terminals, the cover and the sides of the cell cases: clean in warm water with a soft brush.

Rub the cell with a cloth and let dry.

5-1-2. Box (010) and handle (if applicable)

Clean with lightly soapy water, rub with a cloth and let dry.

5-1-3. Nuts, spring washers and links

Clean in lightly soapy water with a brush, rinse well with clean water and let dry.

CLEANING

5-1-4. Liner spacer kit (200) and sensor (if applicable)

Clean in warm water and let dry.

5-1-5. Vent valve (160)

 **The cleaning of the vent valve (160) must be done when the cells are assembled in the box.**

Remove the vent valve (160) (Refer to [DISASSEMBLY](#) chapter).

Cover the cell holes to keep out unwanted material.

Soak the vent valve for some time (during the night, for example) in a container of distilled water to remove all salts from the vent hole.

6. Lubrication

When the battery is clean (and after installation of the vent valve), coat all upper nuts (or screws) (100) and links (030 to 090) with [M02](#).

INSPECTION/CHECK

1. Introduction

1-1. General

This chapter includes the checks, the maintenance procedures and the functional tests that must be done to use Saft batteries in flight and on the ground. These maintenance steps must be completed in a battery shop:

- Periodical check: adjustment of electrolyte levels.
- Regular check: capacity test and periodical check.
- General overhaul: disassembly, full cleaning, assembly and regular check.

NOTE: All () part identification numbers herein are IPL Fig. 1 item numbers.

2. Safety

Refer to chapter [Standard tools](#) in [SPECIAL TOOLS, FIXTURES, EQUIPMENT AND CONSUMABLES](#).

3. Equipment

3-1. Standard tools

Refer to chapter [Standard tools](#) in [SPECIAL TOOLS, FIXTURES, EQUIPMENT AND CONSUMABLES](#).

3-2. Special tools

When special tools are used in this chapter, they are identified by a code number listed in [SPECIAL TOOLS, FIXTURES, EQUIPMENT AND CONSUMABLES](#) chapter.

4. Maintenance intervals

The aircraft manufacturer is responsible for defining the usage and function, including maintenance intervals, for aircraft batteries installed in its aircraft. Saft only provides recommendations that require the agreement of the aircraft manufacturer.

When maintenance intervals are referred to in OPERATING HOURS, it means the sum of the flight and ground operation time when the battery is connected to the aircraft network. The ratio of operating hours to flying hours depends on the operator. It is generally in the range of 1.2 for long range operation to 1.8 for short haul operation.

When maintenance intervals are referred to in CALENDAR TIME it means the time the battery has been installed and operating on-board the aircraft and does not include storage periods

NOTE: Maintenance steps must be completed in a battery shop.

Saft distinguishes between three types of maintenance

4-1. Periodical check

The periodical check consists essentially of voltage and insulation checks, discharge of residual capacity and charge with electrolyte level adjustment. The main purpose of this periodical check is to replace water which is consumed by electrolysis during battery overcharge. It is normally applied between regular checks but can be omitted if the water consumption measured at the regular check is within allowable limits.

4-2. Regular check

The regular check is the same as the periodical check except that the battery is also deep discharged ('balancing'), followed by a capacity check cycle.

4-3. General overhaul

The general overhaul is the same as the regular check except that the battery is also disassembled and thoroughly cleaned and inspected.

5. Recording

It is very important to record the battery check values (capacity, end of charge voltage, water consumption) as required in the battery logbook for each maintenance. It is recommended that an operator tracks these maintenance data in order to verify the interval is correct relative to that particular operation. This may also allow the interval to be extended if the data justifies it.

6. Periodical check

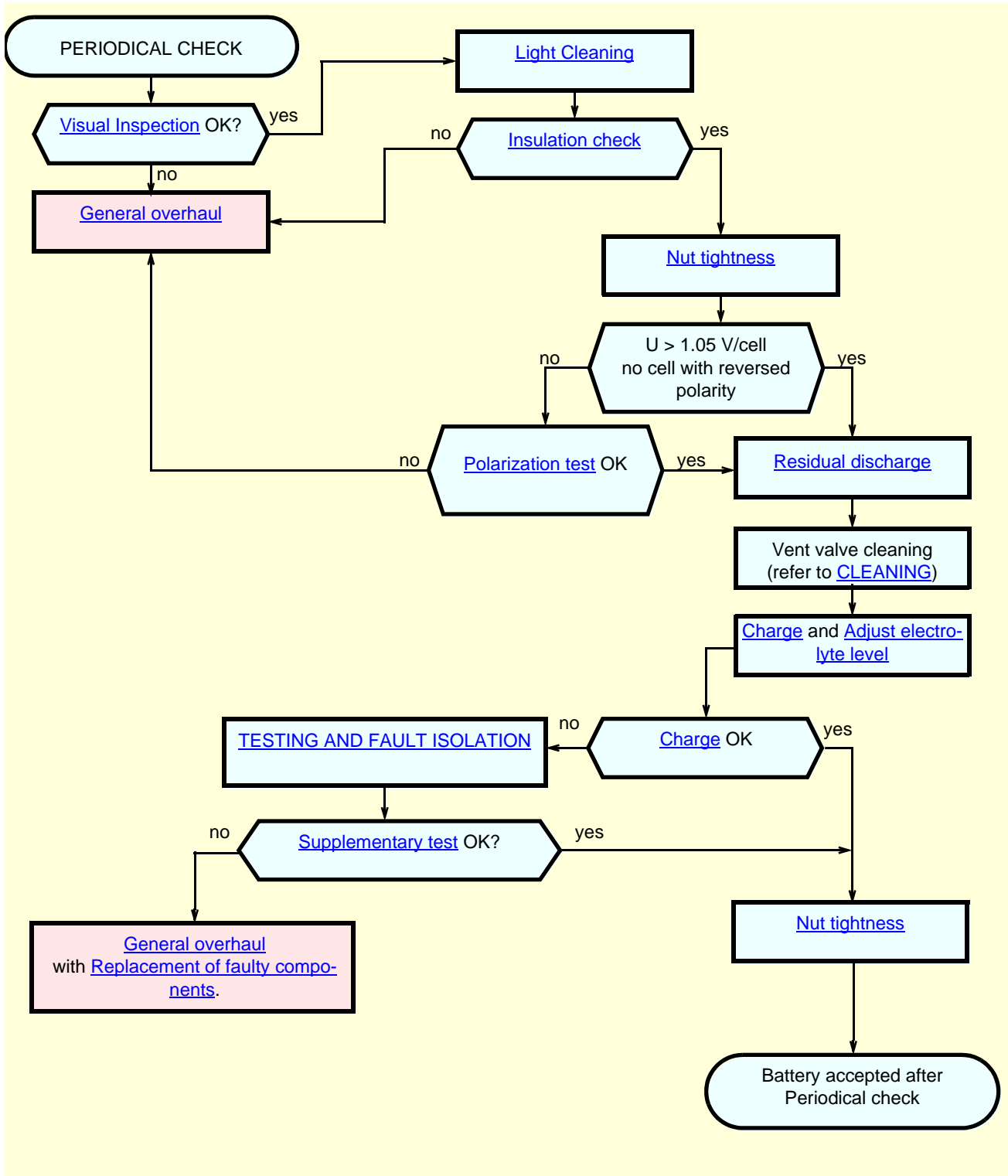

Periodical check
Figure 1

At specific intervals according to aircraft use, or every 3 months, test the battery according to the above figure. Consult the airframe manufacturer for specific maintenance intervals or special procedures to be followed.

NOTE: Time periods are given as a guideline. Modify in accordance with operational experience. Periodic and Regular maintenance checks may be combined if operating hours permit.

6-1. Visual Inspection

Visual inspection should be done each time the battery is removed for maintenance.

- Remove the cover assembly (010).
- Visually check each cell (100) for any evidence of electrolyte leakage. If there is salt or electrolyte traces do a [General overhaul](#). Excessive salts around a terminal post indicates possible leakage from the terminal O-ring. Verify the torque of the lower nut (refer to chapter [ASSEMBLY](#)).
- Inspect the links (030 to 090) and all upper nuts or screws (110), and washers (120 and 150). The hardware should be free of bends, tarnish, corrosion, burns, or any loss of nickel plating. Minor tarnish can be polished off with a fine wire brush. Defective hardware should be replaced.
- Check the main power connector (230) for evidence of arcing, corrosion, cracks, or cross-threaded terminals. Replace any defective connectors.

⚠ Worn aircraft connectors and/or loose connections can greatly affect the performance of the battery. A defective main power connector (230) can cause battery self-discharge as well as low voltage in service.

- If applicable, the temperature sensor and/or heater blanket harness assembly should be inspected for obvious damage. This in no way replaces the full testing procedures found hereafter that ensure full operation of the sensor assembly.
- Inspect the electrical connector for bent or loose pins, corrosion, cracks, faulty wire connections, evidence of arcing, or cracked or loose potting material.
- Inspect the thermistor, thermostat, and/or thermocouple assemblies (as applicable) for any damaged or loose wire connections, cracks, dents, or other physical damage.
- Visually check all wiring insulation to ensure there is no evidence of cracks, cuts, or bubbling. Any evidence of damage to the temperature sensor and/or heater blanket harness assembly indicates a need for a new Saft replacement of the device.
- Inspect the battery box (020) and cover (010) for any damage. Minor dents may be repaired with a small rubber mallet. Ensure the cover gasket (011), if applicable, is undamaged and fully secured to the metal cover (010).

6-2. Insulation check

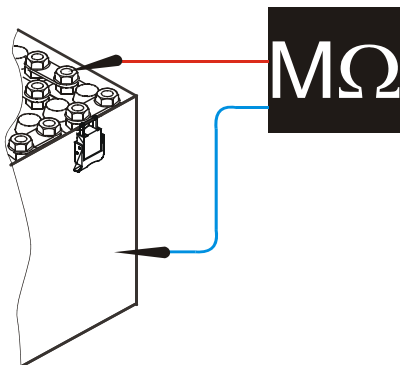

A breakdown in electrical insulation between the cells (100) and the battery box (020) will result in a “leakage” current, which over time will discharge the battery. The most common cause for the loss of insulation is the leakage of electrolyte from the cells (100) that acts as a conductor between the cells and the battery box (020). Because leakage current can affect battery performance, it is necessary that it be kept to a minimum.

On a completely assembled battery, use a megohmmeter, set to 250 V DC, to measure the insulation resistance between the positive terminal of each cell (100) and the battery box (020). Refer to the table below for the acceptance criteria.



INSPECTION/CHECK

6-3. Nut tightness

Tighten and check the torque of all upper cell nuts (110) (refer to [FITS AND CLEARANCES](#)).

6-4. Polarization test

Charge the battery at 0.1C₁A for 1.5 hours.

Keep the battery in open circuit for 1 hour.

Measure the open circuit voltage of each cell. If any cell is zero (0) V or negative polarity, do a [General over-haul](#). If all cells are above zero (0) V, continue with maintenance as specified.

6-5. Residual discharge

Discharge the battery at the 1C₁A or 0.5C₁A rate until each cell in the battery is discharged to 1.0 volt or below.

6-6. Adjust electrolyte level

⚠ Using anything other than distilled or deionized water in nickel-cadmium cells will cause electrolyte contamination and damage.

Always take appropriate precautions to prevent any foreign substances from entering the cell. Anything other than distilled or deionized water that enters the cells will cause electrolyte contamination and will affect overall performance.

The amount of time that the vent-valves are removed from the cell for maintenance should be limited to prevent as much air as possible from entering the cell. Carbon dioxide in the air will combine with the electrolyte to form potassium carbonate. Potassium carbonate will increase the internal resistance of the cells and thus decrease the performance at low temperatures and during high rate discharges. Always ensure that the vent-valves are properly secured while the battery is in use.

Electrolyte level adjustment is to be done during the last 15-30 minutes of the 4 hours overcharge at 0.1C₁A rate of charge.

⚠ Take care not to tilt cells while vent-valves are loosened or removed. Contact of electrolyte with skin can cause burns. If contact occurs, flush area with large amounts of water. Electrolyte in the eyes is very serious. Flush with water and contact a doctor immediately.

⚠ The battery must be fully charged before adjusting the electrolyte level.

Use only distilled or deionized water (see chapter [SPECIAL TOOLS, FIXTURES, EQUIPMENT AND CONSUMABLES](#)).

Do not re-use water removed from cells.

The quantity (in cm³) required to level the first cell will serve as a guide for requirements of the remaining cells but the amount of water required for each cell can vary, so carry out this check on a cell by cell basis. Each cell must be leveled individually. If the quantity of water added per cell is above 80% of the electrolyte water volume shown in the specification tables (refer to chapter [FITS AND CLEARANCES](#)), check the charging system. If it is functioning properly, shorten the time period between servicing.

Adjust the level of electrolyte, one cell at a time, using the following instructions:

- 1. Remove the vent-valves (160) with the vent-valve wrench (T01)
- 2. Check the nozzle length before fitting it to the syringe

- 3. Insert the syringe (T02) into the cell opening until the shoulder of the nozzle rests on the vent-valve seat .

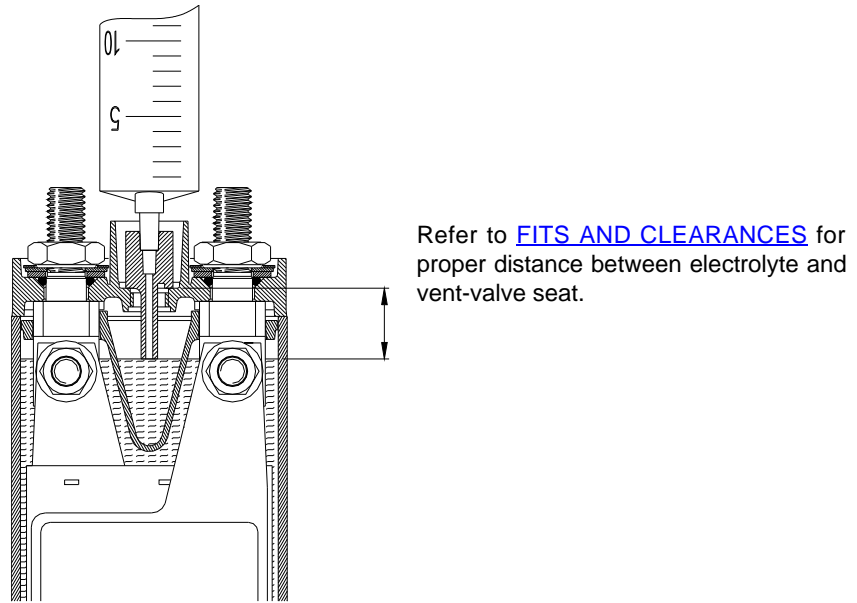

Position of Syringe in Cell Vent Seat
Figure 2

- 4. Withdraw the plunger and check for any liquid in the syringe.
Any excess liquid in the cell will be drawn into the syringe until the electrolyte is level with the end of the nozzle. This is the correct level for the electrolyte.
If the liquid level is too low, the syringe will remain empty, indicating that the end of the syringe nozzle did not reach the liquid in the cell. In this case, replenish low electrolyte.
- 5. Draw 5 cm³ of the distilled water (M01) into the syringe and inject it into the cell.
- 6. With the syringe nozzle remaining on the vent-valve (100) seat, slowly withdraw the plunger in the syringe.
- 7. If the syringe remains empty, repeat steps 5 and 6, counting the number of 5 cm³ injections required to achieve the correct level. Record the amount of water added to each cell on the maintenance record.
- 8. At the point in step 6 when some excess liquid is drawn into the syringe, the correct level for that cell has been reached. Expel the excess liquid into a separate container for disposal. Do not re-use the liquid removed from cells. Check with local authorities for proper disposal of hazardous waste.

6-7. Supplementary test

At the end of complete charge (refer to [Constant Current Charge](#)), continue to charge for 5 h at 0.1 C₁A.

Measure the voltage of the individual cell voltages every 30 min. The individual cell voltages:

- must not decrease by 0.03 V during the test
- must be
 - $U \geq 1.5 \text{ V}$ for VO/VP/VHP/VXP
 - $U \geq 1.55 \text{ V}$ for CVH/CVD/CVK
- Adjust the electrolyte level (refer to [Adjust electrolyte level](#)).

7. Regular check

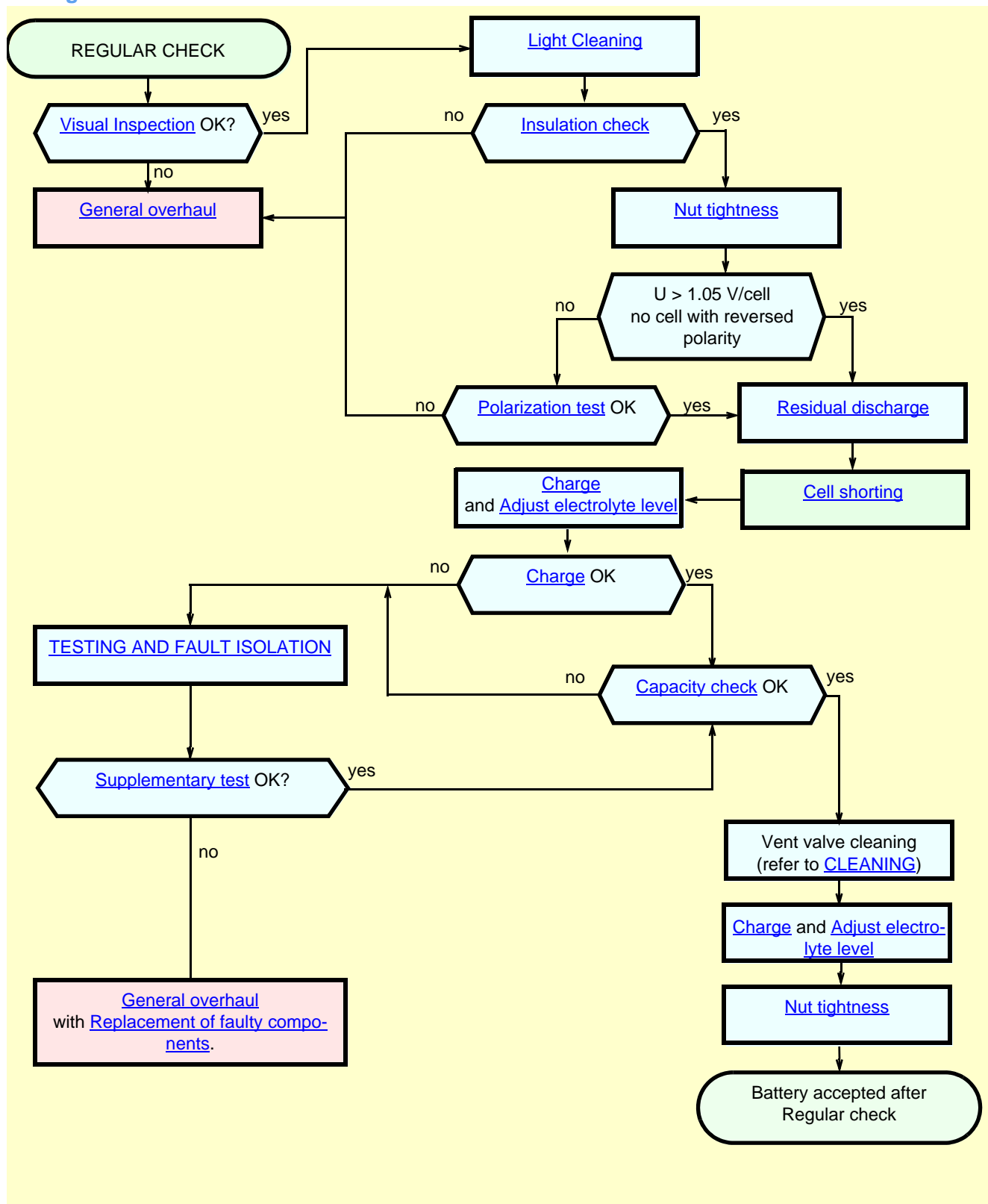

Regular check
Figure 3

At specific intervals according to aircraft use, or AFTER A MAXIMUM OF 6 MONTHS, test the battery according to the above figure. Consult the airframe manufacturer for specific maintenance intervals or special procedures to be followed.

NOTE: Time periods are given as a guideline. Modify in accordance with operational experience. Periodic and Regular maintenance checks may be combined if operating hours permits.

7-1. Cell shorting

As each cell's voltage drops below 1.0 V, connect an equalizing resistor (T03) across each cell's terminals. Leave the resistors in place for 12 to 16 hours to allow each cell to completely discharge and the battery to cool.

NOTE: As an alternative to the resistor a shorting clip can be applied when the voltage has dropped to 0.5 V/cell.

7-2. Capacity check

Discharge the battery at 1C₁A. Record the time that the first cell reaches 1.0 volt. This time must be equal or greater to 51 min for VO and VP and 1 h for VHP, VXP, CVH, CVD and CVK cells.

8. General overhaul

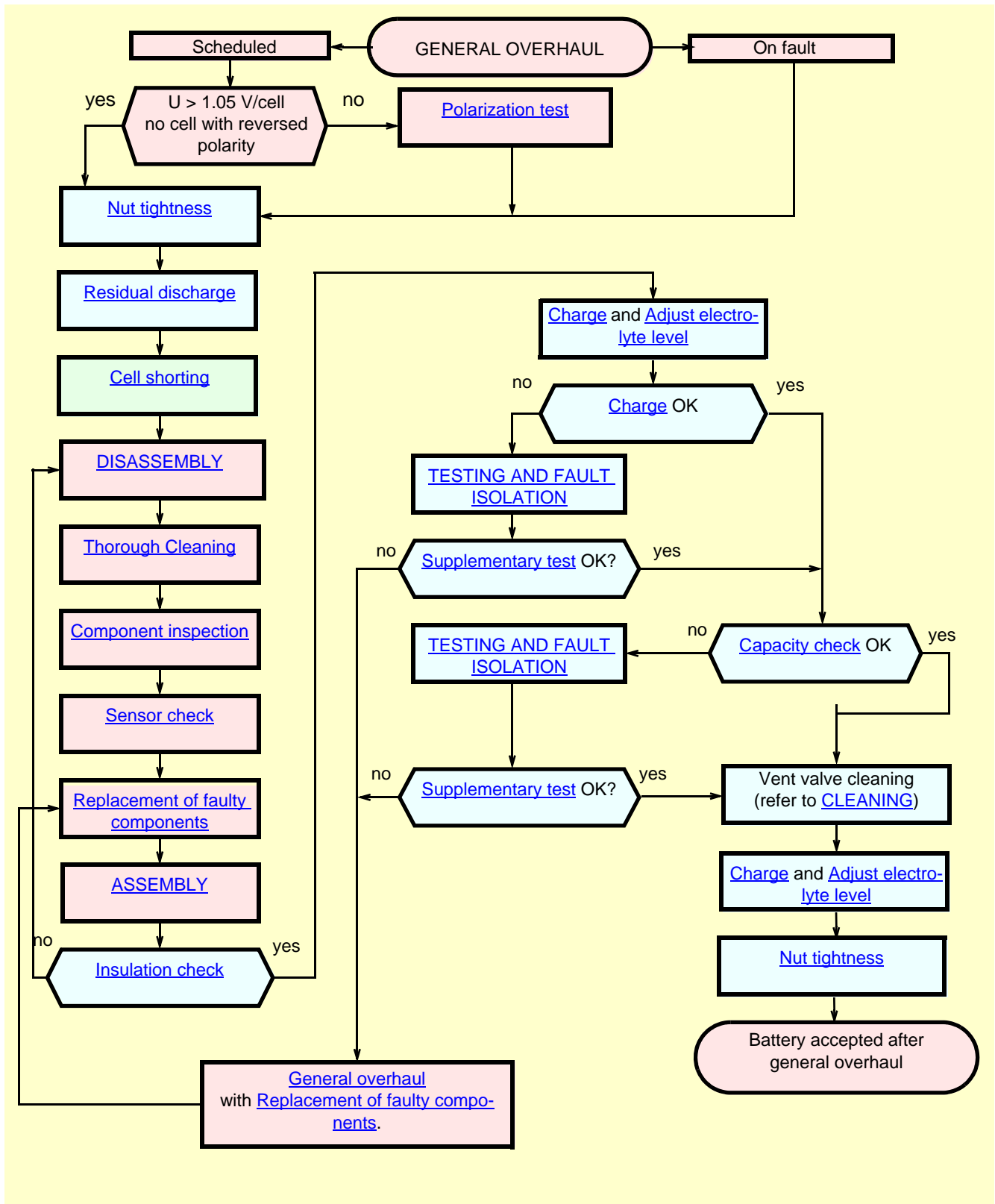

General overhaul
Figure 4

At specific intervals according to aircraft use, or AFTER A MAXIMUM OF ONE YEAR, test the battery according to the above figure. Consult the airframe manufacturer for specific maintenance intervals or special procedures to be followed.

8-1. Component inspection

8-1-1. Cells

Make sure that the lower terminal nuts are tight (refer to [FITS AND CLEARANCES](#) chapter).
Verify that cell boxes show no leakage.

8-1-2. Box

Make the sides of the box straight and remove dents.

8-1-3. Nuts, links and spring washers

Discard the components that show signs of corrosion or damage.

8-1-4. Packing parts

Discard all defective components.

8-1-5. Connector

Check the main power connector ([230](#)) for evidence of arcing, corrosion, cracks, or cross-threaded terminals. Replace any defective connectors.

8-2. Replacement of faulty components

8-2-1. Cells

NOTE: If one or more cells are found to be faulty and 5 of the original cells in the battery have previously been changed, or if 3 or more cells are found to be faulty during the same maintenance, then change all the cells or replace the complete battery.

Any cells that are to be changed must be replaced by a new Saft cell.

8-2-2. Other components

Any other components that are to be changed must be replaced by a new Saft component.

8-3. Sensor check

8-3-1. Insulation check

Verify that the insulation between each pin of the connector and all metal parts of the sensor is > 10 MΩ @ 250 V DC

8-3-2. Sensor check

Check the sensor, if applicable, according to the table below:

Battery description	F6177 P/N Sensor	V09052 P/N Sensor	Check
176CH		019271-000	A-B: close on rise @ 63 °C ± 2.8 °C (146 °F ± 5 °F) C-D: close on rise @ 63 °C ± 2.8 °C (146 °F ± 5 °F)
176CH6		023669-000	
272CH1	412757	023258-000	1-2: close on rise @ 71 °C ± 2.8 °C (160 °F ± 5 °F) 1-3: close on rise @ 71 °C ± 2.8 °C (160 °F ± 5 °F) 2-3: short circuit
276CH7	413032		A-B: 200 Ω ± 2 Ω @ 60 °C ± 1 °C (141 °F ± 2.8 °F) A-B: 174 Ω ± 5 Ω @ 24 °C ± 3 °C (75 °F ± 5 °F)
276CH10	166900	018802-000	A-B: 49.75 KΩ @ 25 °C (73 °F) B-C: 300 KΩ @ 25 °C (73 °F)
277CH1	161297		B-E: close on rise @ 57 °C ± 2.8 °C (135 °F ± 5 °F) D-L1: short circuit
310VX-2	411980		A-B: 3 KΩ @ 25 °C (73 °F) C: middle point with 4.99 KΩ 1% resistor D-E: close on rise @ 71 °C ± 2.8 °C (160 °F ± 5 °F)
345CD1	411991		B-C: close on rise @ 65 °C ± 2.8 °C (149 °F ± 5 °F) B-D: short circuit
405CH3	415512		A-B: 2252 Ω ± 1% @ 25 °C (77 °F) C-+: 5 kΩ ± 1% D-middle point: E-F: open on rise @ 71 °C ± 2.8 °C (160 °F ± 5 °F) G--: 5 kΩ ± 1%
407CH-2		023697-000	A-B: open on rise @ 71 °C ± 2.8 °C (160 °F ± 5 °F) C-D: close after open 60 °C ± 2.8 °C (140 °F ± 5 °F)

INSPECTION/CHECK

Battery description	F6177 P/N Sensor	V09052 P/N Sensor	Check
407CH5	114722	017125-000	C-D: close on rise @ 71 °C ± 2.8 °C (160 °F ± 5 °F)
407CH-11		019422-000	4-6: short circuit 8-9: open on rise @ 67 °C ± 2.8 °C (154 °F ± 5 °F) 11-12: 2.46 KΩ ± 25 Ω @ 23 °C (73 °F)
407CH13	413861	019504-000	A-B: 174 Ω @ 23.9 °C (75 °F) A-B: 200 Ω @ 60 °C (140 °F) C-D: 174 Ω @ 23.9 °C (75 °F) C-D: 200 Ω @ 60 °C (140 °F)
435CH6		026317-000	A-C: close on rise @ 71 °C ± 2.8 °C (160 °F ± 5 °F) B-D: 110 Ω ± 1% @ 25 °C (77 °F)
437CH14	413861	019504-000	A-B: 174 Ω @ 23.9 °C (75 °F) A-B: 200 Ω @ 60 °C (140 °F) C-D: 174 Ω @ 23.9 °C (75 °F) C-D: 200 Ω @ 60 °C (140 °F)
438CH2		023669-000	
442CH2	114722	017125-000	C-D: close on rise @ 71 °C ± 2.8 °C (160 °F ± 5 °F)
447CH1	414976		A-B: close on rise @ 71 °C ± 2.8 °C (160 °F ± 5 °F) A-C: close on rise @ 71 °C ± 2.8 °C (160 °F ± 5 °F)
505CH3	114722	017125-000	C-D: close on rise @ 71 °C ± 2.8 °C (160 °F ± 5 °F)
616	411157		A-B: close on rise @ 57 °C ± 2.8 °C (135 °F ± 5 °F) B-C: close on rise @ 71 °C ± 2.8 °C (160 °F ± 5 °F)
1277-1	114722	017125-000	C-D: close on rise @ 71 °C ± 2.8 °C (160 °F ± 5 °F)
1277-2		019656-000	
1277-3	414139		A-B: 30 KΩ @ 25 °C (77 °F) C-D: close on rise @ 71 °C ± 2.8 °C (160 °F ± 5 °F)
1608-1	412757	023258-000	1-2: close on rise @ 71 °C ± 2.8 °C (160 °F ± 5 °F) 1-3: close on rise @ 71 °C ± 2.8 °C (160 °F ± 5 °F) 2-3: short circuit
1656-1	114722	017125-000	C-D: close on rise @ 71 °C ± 2.8 °C (160 °F ± 5 °F)
1656-2	162901		C-D: close on rise @ 57 °C ± 2.8 °C (135 °F ± 5 °F)
1656-5	117497	019220-000	A-B: close on rise @ 57 °C ± 2.8 °C (135 °F ± 5 °F) C-D: close on rise @ 71 °C ± 2.8 °C (160 °F ± 5 °F)
1658-2	162901		C-D: close on rise @ 57 °C ± 2.8 °C (135 °F ± 5 °F)
1666-1	116051	018652-000	A-B: close on rise @ 71 °C ± 2.8 °C (160 °F ± 5 °F) B-C: short circuit
1756		019271-000	A-B: close on rise @ 63 °C ± 2.8 °C (146 °F ± 5 °F) C-D: close on rise @ 63 °C ± 2.8 °C (146 °F ± 5 °F)
1756-2		023808-500	A-B: close on rise @ 57 °C ± 2.8 °C (135 °F ± 5 °F) C-D: close on rise @ 71 °C ± 2.8 °C (160 °F ± 5 °F)
2353-1	114722	017125-000	C-D: close on rise @ 71 °C ± 2.8 °C (160 °F ± 5 °F)
2371-1	114722	017125-000	C-D: close on rise @ 71 °C ± 2.8 °C (160 °F ± 5 °F)
2371-2	162901		C-D: close on rise @ 57 °C ± 2.8 °C (135 °F ± 5 °F)
2371-4	166900	018802-000	A-B: 49.75 KΩ @ 25 °C (73 °F) B-C: 300 KΩ @ 25 °C (73 °F)
2371-5	162366	019437-000	AF-BC: close on rise @ 71 °C ± 2.8 °C (160 °F ± 5 °F) AF-DE: close on rise @ 57 °C ± 2.8 °C (135 °F ± 5 °F)
2371-6	410156		A-B: close on rise @ 57 °C ± 2.8 °C (135 °F ± 5 °F) B-E: close on rise @ 57 °C ± 2.8 °C (135 °F ± 5 °F) C-D: close on rise @ 65 °C (145 °F) C-E: close on rise @ 65 °C (145 °F)
2371-7	411345		A-C: 100 Ω @ 23 °C (73 °F) B-C: 30 KΩ @ 23 °C (73 °F) D-E: 100 Ω @ 23 °C (73 °F) E-F: 30 KΩ @ 23 °C (73 °F)
2376-1	114722	017125-000	C-D: close on rise @ 71 °C ± 2.8 °C (160 °F ± 5 °F)
2376-2	117497	019220-000	A-B: close on rise @ 57 °C ± 2.8 °C (135 °F ± 5 °F) C-D: close on rise @ 71 °C ± 2.8 °C (160 °F ± 5 °F)
2376-3		018484-000	1-2: close on rise @ 57 °C ± 2.8 °C (135 °F ± 5 °F) 3-4: close on rise @ 57 °C ± 2.8 °C (135 °F ± 5 °F)

Battery description	F6177 P/N Sensor	V09052 P/N Sensor	Check
2376-4	166900	018802-000	A-B: 49.9 K Ω @ 25 °C (77 °F) B-C: 300 K Ω @ 25 °C (77 °F)
2376-7	413032		A-B: 200 Ω \pm 2 Ω @ 60 °C \pm 1 °C (141 °F \pm 2.8 °F) A-B: 174 Ω \pm 5 Ω @ 24 °C \pm 3 °C (75 °F \pm 5 °F)
2376-8	413469		AB: close on rise @ 71 °C \pm 2.8 °C (160 °F \pm 5 °F)
2376-9		018932-000	A-B: 174 Ω @ 24 °C (75 °F) A-B: 200 Ω @ 60 °C (140 °F) C-D: 174 Ω @ 24 °C (75 °F) C-D: 200 Ω @ 60 °C (140 °F)
2376-10		019498-000	A-B: close on rise @ 63 °C \pm 2.8 °C (146 °F \pm 5 °F)
2386-1	117497	019220-000	A-B: close on rise @ 57 °C \pm 2.8 °C (135 °F \pm 5 °F) C-D: close on rise @ 71 °C \pm 2.8 °C (160 °F \pm 5 °F)
2506-1	116051	018652-000	A-B: close on rise @ 71 °C \pm 2.8 °C (160 °F \pm 5 °F) B-C: short circuit
2506-2	116051	018652-000	A-B: close on rise @ 71 °C \pm 2.8 °C (160 °F \pm 5 °F) B-C: short circuit
2708-1	411758		C-D: close on rise @ 71 °C \pm 2.8 °C (160 °F \pm 5 °F)
2708-2	114722	017125-000	C-D: close on rise @ 71 °C \pm 2.8 °C (160 °F \pm 5 °F)
2778-2	117497	019220-000	A-B: close on rise @ 57 °C \pm 2.8 °C (135 °F \pm 5 °F) C-D: close on rise @ 71 °C \pm 2.8 °C (160 °F \pm 5 °F)
2778-5	166578		A-B: 40 K Ω @ 23 °C (73 °F) E-F: 40 K Ω @ 23 °C (73 °F) D-G: short circuit
2778-10	413032		A-B: 200 Ω \pm 2 Ω @ 60 °C \pm 1 °C (141 °F \pm 2.8 °F) A-B: 174 Ω \pm 5 Ω @ 24 °C \pm 3 °C (75 °F \pm 5 °F)
2778-15	413330		A-B: close on rise @ 71 °C \pm 2.8 °C (160 °F \pm 5 °F) C-D: close on rise @ 71 °C \pm 2.8 °C (160 °F \pm 5 °F) E-F: open on rise @ 71 °C \pm 2.8 °C (160 °F \pm 5 °F)
2778-18	413032		A-B: 200 Ω \pm 0.5 Ω @ 60 °C (140 °F) A-B: 174 Ω \pm 5 Ω @ 21-27 °C (70-80 °F)
4000A1-1	116051	018652-000	A-B: close on rise @ 71 °C \pm 2.8 °C (160 °F \pm 5 °F) B-C: short circuit
4006A-1	116051	018652-000	A-B: close on rise @ 71 °C \pm 2.8 °C (160 °F \pm 5 °F) B-C: short circuit
4008-1	116051	018652-000	A-B: close on rise @ 71 °C \pm 2.8 °C (160 °F \pm 5 °F) B-C: short circuit
4015CH-11		019422-000	4-6: short circuit 8-9: open on rise @ 67 °C \pm 2.8 °C (154 °F \pm 5 °F) 11-12: 2.46 K Ω \pm 25 Ω @ 23 °C (73 °F)
4017CH-1	116109	016420-000	1-2: close on rise @ 57 °C \pm 2.8 °C (135 °F \pm 5 °F) 3-4: opens on rise @ 8 °C \pm 2.8 °C (46 °F \pm 5 °F)
4050A1-1	114722	017125-000	C-D: close on rise @ 71 °C \pm 2.8 °C (160 °F \pm 5 °F)
4071-1	114722	017125-000	C-D: close on rise @ 71 °C \pm 2.8 °C (160 °F \pm 5 °F)
4071-2	117497	019220-000	A-B: close on rise @ 57 °C \pm 2.8 °C (135 °F \pm 5 °F) C-D: close on rise @ 71 °C \pm 2.8 °C (160 °F \pm 5 °F)
4071-3		023046-000	A-B: close on rise @ 63 °C \pm 2.8 °C (146 °F \pm 5 °F) C-D: close on rise @ 63 °C \pm 2.8 °C (146 °F \pm 5 °F)
4071-10	166900	018802-000	A-B: 49.9 K Ω @ 25 °C (77 °F) B-C: 300 K Ω @ 25 °C (77 °F)
4076-1	114722	017125-000	C-D: close on rise @ 71 °C \pm 2.8 °C (160 °F \pm 5 °F)
4076-2	161057		C-D: close on rise @ 57 °C \pm 2.8 °C (135 °F \pm 5 °F)
4076-8		019757-000	A-L1: short circuit B-C: 3 K Ω @ 25 °C (77 °F)
4076-9	410929	019756-000	A-C/D-F: 100 Ω @ 25 °C (77 °F) B-C/E-F: 30 K Ω @ 25 °C (77 °F)
4076-11		019422-000	4-6: short circuit 8-9: open on rise @ 67 °C \pm 2.8 °C (154 °F \pm 5 °F) 11-12: 2.46 K Ω \pm 25 Ω @ 23 °C (73 °F)
4076-12		019498-000	A-B: close on rise @ 63 °C \pm 2.8 °C (146 °F \pm 5 °F)

INSPECTION/CHECK

Battery description	F6177 P/N Sensor	V09052 P/N Sensor	Check
4076-13	413861	019504-000	A-B: 174 Ω @ 23.9 °C (75 °F) A-B: 200 Ω @ 60 °C (140 °F) C-D: 174 Ω @ 23.9 °C (75 °F) C-D: 200 Ω @ 60 °C (140 °F)
4076-15	412812	024558-000	B-C: close on rise @ 57 °C ± 2.8 °C (135 °F ± 5 °F) E-F: close on rise @ 57 °C ± 2.8 °C (135 °F ± 5 °F)
4076-16	412160		A-B: close on rise @ 71 °C ± 2.8 °C (160 °F ± 5 °F)
4076-17	413033		A-B: 200 Ω @ 60 °C ± 2.8 °C (140 °F ± 5 °F) A-B: 174 Ω @ 21/27 °C (70/80 °F)
4076-19		023627-000	A-L1: short circuit B-C: 3 KΩ @ 25 °C (77 °F)
4076-21	412299		A-B: close on rise @ 71 °C ± 2.8 °C (160 °F ± 5 °F) C-D: close on rise @ 71 °C ± 2.8 °C (160 °F ± 5 °F) D-E: short circuit
4078-1	114722	017125-000	C-D: close on rise @ 71 °C ± 2.8 °C (160 °F ± 5 °F)
4078-5	117497	019220-000	A-B: close on rise @ 57 °C ± 2.8 °C (135 °F ± 5 °F) C-D: close on rise @ 71 °C ± 2.8 °C (160 °F ± 5 °F)
4078-6		019422-000	4-6: 0 Ω @ 23 °C (73 °F) 8-9: open on rise @ 67 °C ± 2.8 °C (154 °F ± 5 °F) 11-12: 2.46 KΩ ± 25 Ω @ 23 °C (73 °F)
4078-9	410669	021936-000	A-B: close on rise @ 57 °C ± 2.8 °C (135 °F ± 5 °F) C-D: close on rise @ 71 °C ± 2.8 °C (160 °F ± 5 °F) E-F: 98 Ω @ 20 °C (68 °F)
4078-10	410929	019756-000	A-C/D-F: 100 Ω @ 25 °C (77 °F) B-C/E-F: 30 KΩ @ 25 °C (77 °F)
4078-11	413351		A-B: close on rise 57 °C ± 2.8 °C (135 °F ± 5 °F) C-D: close on rise @ 71 °C ± 2.8 °C (160 °F ± 5 °F) E-F: 140 Ω @ 25 °C (77 °F)
4078-12	412299		A-B: close on rise @ 71 °C ± 2.8 °C (160 °F ± 5 °F) C-D: close on rise @ 71 °C ± 2.8 °C (160 °F ± 5 °F) D-E: short circuit
4078-13	166900	018802-000	A-B: 49.9 KΩ @ 25 °C (77 °F) B-C: 300 KΩ @ 25 °C (77 °F)
4078-14	413861	019504-000	A-B: 174 Ω @ 23.9 °C (75 °F) A-B: 200 Ω @ 60 °C (140 °F) C-D: 174 Ω @ 23.9 °C (75 °F) C-D: 200 Ω @ 60 °C (140 °F)
4078-15	413011		A-B: open on rise @ -12 °C (-10.4 °F) B-C: R=13 Ω open on rise @ -12 °C (-10.4 °F) D-E: close on rise @ 71 °C ± 2.8 °C (160 °F ± 5 °F)
4078-16	413339		A-B: close on rise @ 65 °C ± 2.8 °C (150 °F ± 5 °F) C-D: close on rise @ 65 °C ± 2.8 °C (150 °F ± 5 °F)
4078-18	412812	024558-000	B-C: close on rise @ 57 °C ± 2.8 °C (135 °F ± 5 °F) E-F: close on rise @ 57 °C ± 2.8 °C (135 °F ± 5 °F)
4078-19		023697-000	A-B: open on rise @ 71 °C ± 2.8 °C (160 °F ± 5 °F) C-D: close after open 60 °C ± 2.8 °C (140 °F ± 5 °F)
4078-21	413033		A-B: 200 Ω @ 60 °C ± 2.8 °C (140 °F ± 5 °F) A-B: 174 Ω @ 21/27 °C (70/80 °F)
4078-25	415137		A: middle point C-D: open on rise @ 71 °C (160 °F) E-F: 2.25 KΩ @ 25 °C (73 °F)
4079-1	161057		C-D: close on rise @ 57 °C ± 2.8 °C (135 °F ± 5 °F)
4079-2	117497	017753-000	A-B: close on rise @ 57 °C ± 2.8 °C (135 °F ± 5 °F) C-D: close on rise @ 71 °C ± 2.8 °C (160 °F ± 5 °F)
4079-4		019757-000	A-L1: short circuit B-C: 3 KΩ @ 25 °C (77 °F)
4079-6	114722	017125-000	C-D: close on rise @ 71 °C ± 2.8 °C (160 °F ± 5 °F)
4079-9	413084		A: + B: - C-D: 15 kΩ @ 25 °C (77 °F) E-F: 15 kΩ @ 25 °C (77 °F) G-H: 15 kΩ @ 25 °C (77 °F)
4079-10		024976-500	A-B: 300 KΩ ± 2.9 KΩ @ 25 °C (73 °F) C-E: close on rise @ 60 °C ± 2.8 °C (140 °F ± 5 °F) D-F: close on rise @ 71 °C ± 2.8 °C (160 °F ± 5 °F)

Battery description	F6177 P/N Sensor	V09052 P/N Sensor	Check
4317CH1		016420-000	1-2: close on rise @ 57 °C ± 2.8 °C (135 °F ± 5 °F) 3-4: close on fall @ 8 °C ± 2.8 °C (46 °F ± 5 °F)
4410CH1	415378		A-B: close on rise @ 57 °C ± 2.8 °C (135 °F ± 5 °F) C-D: close on rise @ 71 °C ± 2.8 °C (160 °F ± 5 °F)
4417CH14	413861	019504-000	A-B: 174 Ω @ 23.9 °C (75 °F) A-B: 200 Ω @ 60 °C (140 °F) C-D: 174 Ω @ 23.9 °C (75 °F) C-D: 200 Ω @ 60 °C (140 °F)
5512CH1		022036-000	C-E: 2 KΩ ± 20 Ω @ 25 °C (73 °F) G-+: 1 KΩ ± 100 Ω @ 25 °C (73 °F) C-battery case: > 20 MΩ F-battery case: > 20 MΩ
12277-1		017125-000	C-D: close on rise @ 71 °C ± 2.8 °C (160 °F ± 5 °F)
12277-2		019787-000	A-B: 30.1 KΩ @ 25 °C (77 °F) A-C: 100 Ω @ 25 °C (77 °F) B-C: 30 KΩ @ 25 °C (77 °F) D-E: 30.1 KΩ @ 25 °C (77 °F) D-F: 100 Ω @ 25 °C (77 °F) E-F: 30 KΩ @ 25 °C (77 °F)
16106-1	412759		A-B: close on rise @ 71 °C ± 2.8 °C (160 °F ± 5 °F) B-C: 0 Ω @ 23 °C (73 °F)
16108-1	412759		A-B: close on rise @ 71 °C ± 2.8 °C (160 °F ± 5 °F) B-C: 0 Ω @ 23 °C (73 °F)
16156-1	117497		A-B: close on rise @ 57 °C ± 2.8 °C (135 °F ± 5 °F) C-D: close on rise @ 71 °C ± 2.8 °C (160 °F ± 5 °F)
16256-3		019384-000	B-C: close on rise @ 71 °C ± 2.8 °C (160 °F ± 5 °F) C-D: close on rise @ 71 °C ± 2.8 °C (160 °F ± 5 °F)
16258	410922		A: middle point B-C: 3 KΩ ± 1% @ 25 °C (77 °F) E-F: close on rise @ 71 °C ± 2.8 °C (160 °F ± 5 °F)
20126-2		018582-000	A-B: 174 Ω @ 24 °C (75 °F) A-B: 200 Ω @ 60 °C ± 2.8 °C (140 °F ± 5 °F)
20126-3		018581-000	A-B: 174 Ω @ 24 °C (75 °F) A-B: 200 Ω @ 60 °C (140 °F) C-D: 174 Ω @ 24 °C (75 °F) C-D: 200 Ω @ 60 °C (140 °F)
23171-4	166900	018802-000	A-B: 49.75 KΩ @ 25 °C (73 °F) B-C: 300 KΩ @ 25 °C (73 °F)
23175	116312	015949-000	1-2: close on rise @ 57 °C ± 2.8 °C (135 °F ± 5 °F)
23176	116312	015949-000	1-2: close on rise @ 57 °C ± 2.8 °C (135 °F ± 5 °F)
23376	161297		B-E: close on rise @ 57 °C ± 2.8 °C (135 °F ± 5 °F) D-L1: short circuit
23476	161057		C-D: close on rise @ 57 °C ± 2.8 °C (135 °F ± 5 °F)
23478	161057		C-D: close on rise @ 57 °C ± 2.8 °C (135 °F ± 5 °F)
23491	117497	017753-000	A-B: close on rise @ 57 °C ± 2.8 °C (135 °F ± 5 °F) C-D: close on rise @ 71 °C ± 2.8 °C (160 °F ± 5 °F)
23491-3	413049		A-B: close on rise @ 57 °C ± 2.8 °C (135 °F ± 5 °F) C-D: close on rise @ 71 °C ± 2.8 °C (160 °F ± 5 °F) E-F: 143 Ω @ 25 °C (73 °F)
23491-4	414890		A-B: close on rise @ 57 °C ± 2.8 °C (135 °F ± 5 °F) C-D: close on rise @ 71 °C ± 2.8 °C (160 °F ± 5 °F) E-F: 143 Ω @ 25 °C (73 °F) G-H: opens on rise @ 8 °C ± 2.8 °C (46 °F ± 5 °F)
23498-1	117497	019220-000	A-B: close on rise @ 57 °C ± 2.8 °C (135 °F ± 5 °F) C-D: close on rise @ 71 °C ± 2.8 °C (160 °F ± 5 °F)
23576-1		018802-000	A-B: 49.75 KΩ @ 25 °C (73 °F) B-C: 300 KΩ @ 25 °C (73 °F)
23576-2		019493-000	
23676-1	166900	018802-000	A-B: 49.75 KΩ @ 25 °C (73 °F) B-C: 300 KΩ @ 25 °C (73 °F)
23676-2		019747-000	L1: open on rise @ 65 °C ± 2.8 °C (150 °F ± 5 °F)
23678-1	162901		C-D: close on rise @ 57 °C ± 2.8 °C (135 °F ± 5 °F)

INSPECTION/CHECK

Battery description	F6177 P/N Sensor	V09052 P/N Sensor	Check
23678-2	411345		A-C: 100 Ω @ 23 °C (73 °F) B-C: 30 KΩ @ 23 °C (73 °F) D-E: 100 Ω @ 23 °C (73 °F) E-F: 30 KΩ @ 23 °C (73 °F)
23678-3	413031		A-B: close on rise @ 57 °C ± 2.8 °C (135 °F ± 5 °F) C-D: open on rise @ 71 °C ± 2.8 °C (160 °F ± 5 °F)
25106-2	165226		A-B: close on rise @ 57 °C ± 2.8 °C (135 °F ± 5 °F) C-D: close on rise @ 71 °C ± 2.8 °C (160 °F ± 5 °F) F: box
26108-3	414093		A-B: close on rise @ 71 °C ± 2.8 °C (160 °F ± 5 °F)
26108-4	414137		A-B: close on rise @ 71 °C ± 2.8 °C (160 °F ± 5 °F) C-D: close on rise @ 57 °C ± 2.8 °C (135 °F ± 5 °F)
26108-5	414182		A-B: close on rise @ 71 °C ± 2.8 °C (160 °F ± 5 °F)
26108-7	415280		A-B: close on rise @ 71 °C ± 2.8 °C (160 °F ± 5 °F) C-D: 300 KΩ @ 25 °C (77 °F)
26308-1	114722	017125-000	C-D: close on rise @ 71 °C ± 2.8 °C (160 °F ± 5 °F)
26308-5	166900	018802-000	A-B: 49.75 KΩ @ 25 °C (73 °F) B-C: 300 KΩ @ 25 °C (73 °F)
26408-1	114722	017125-000	C-D: close on rise @ 71 °C ± 2.8 °C (160 °F ± 5 °F)
26508-1	116051		A-B: close on rise @ 71 °C ± 2.8 °C (160 °F ± 5 °F) C-D: short circuit
27168-1	411345		A-C: 100 Ω @ 25 °C (77 °F) B-C: 30 KΩ @ 25 °C (77 °F) D-F: 100 Ω @ 25 °C (77 °F) E-F: 30 KΩ @ 25 °C (77 °F)
27278-2	117497	017753-000	A-B: close on rise @ 57 °C ± 2.8 °C (135 °F ± 5 °F) C-D: close on rise @ 71 °C ± 2.8 °C (160 °F ± 5 °F)
27578-2	117497	019220-000	A-B: close on rise @ 57 °C ± 2.8 °C (135 °F ± 5 °F) C-D: close on rise @ 71 °C ± 2.8 °C (160 °F ± 5 °F)
40100-1	114722	017125-000	C-D: close on rise @ 71 °C ± 2.8 °C (160 °F ± 5 °F)
40108-2	166900	018802-000	A-B: 49.75 KΩ @ 25 °C (73 °F) B-C: 300 KΩ @ 25 °C (73 °F)
40176-10		023172-000	
40178-7	410669	021564-000	A-B: close on rise @ 57 °C ± 2.8 °C (135 °F ± 5 °F) C-D: close on rise @ 71 °C (160 °F) E-F: 91 Ω @ 0 °C (32 °F)
40178-21	413033		A-B: 200 Ω @ 60 °C ± 2.8 °C (140 °F ± 5 °F) A-B: 174 Ω @ 21/27 °C (70/80 °F)
40179-7	116109	016420-000	1-2: close on rise @ 57 °C ± 2.8 °C (135 °F ± 5 °F) 3-4: opens on rise @ 8 °C ± 2.8 °C (46 °F ± 5 °F)
40200-1	413455		A-B: close on rise @ 57 °C ± 2.8 °C (135 °F ± 5 °F) C-D: close on rise @ 71 °C ± 2.8 °C (160 °F ± 5 °F)
40206-2	115807		C-D: close on rise @ 71 °C ± 2.8 °C (160 °F ± 5 °F)
40208-1	166854		A-B: 111 Ω ± 4 Ω @ 20 °C ± 2 °C (68 °F ± 3.6 °F) B-C: 111 Ω ± 4 Ω @ 20 °C ± 2 °C (68 °F ± 3.6 °F)
40208-2	114722	017125-000	C-D: close on rise @ 71 °C ± 2.8 °C (160 °F ± 5 °F)
40208-4	410718		A-B: T1 OPEN @ -12 °C (-56 °F) A-B: R1 23 Ω @ 23 °C (73 °F)
40208-5	411124		A-B: 111 Ω ± 4 Ω @ 20 °C ± 2 °C (68 °F ± 3.6 °F) B-C: 111 Ω ± 4 Ω @ 20 °C ± 2 °C (68 °F ± 3.6 °F) D-E: open on rise @ -5 °C (23 °F) E-F: open on rise @ -15 °C (5 °F) with R = 23 Ω ± 2.3 Ω
40208-6	411980		A-B: 33 kΩ 1% @ 25 °C (77 °F) C: middle point E-F: close on rise @ 71 °C ± 2.8 °C (160 °F ± 5 °F)
40208-7	413455		A-B: close on rise @ 57 °C ± 2.8 °C (135 °F ± 5 °F) C-D: close on rise @ 71 °C ± 2.8 °C (160 °F ± 5 °F)
40209-2	166900	018802-000	A-B: 49.75 KΩ @ 25 °C (73 °F) B-C: 300 KΩ @ 25 °C (73 °F)
40278-2	117497	019220-000	A-B: close on rise @ 57 °C ± 2.8 °C (135 °F ± 5 °F) C-D: close on rise @ 71 °C ± 2.8 °C (160 °F ± 5 °F)

Battery description	F6177 P/N Sensor	V09052 P/N Sensor	Check
40278-14	413861	019504-000	A-B: 174 Ω @ 23.9 °C (75 °F) A-B: 200 Ω @ 60 °C (140 °F) C-D: 174 Ω @ 23.9 °C (75 °F) C-D: 200 Ω @ 60 °C (140 °F)
40478-1		021173-500	A-B: open on rise @ 60 °C ± 2.8 °C (140 °F ± 5 °F) D-G: open on rise @ 65 °C ± 2.8 °C (150 °F ± 5 °F) E-F: 2.46 kΩ ± 0.25 Ω @ 25 °C (77 °F)
40508-1	410929	019756-000	A-C/D-F: 100 Ω @ 25 °C (77 °F) B-C/E-F: 30 KΩ @ 25 °C (77 °F)
40576-3		017694-000	BC: 3 KΩ @ 25 °C (77 °F)
40576-14		017446-000	A-B: 49.75 KΩ @ 25 °C (77 °F) B-C: 300 KΩ @ 25 °C (77 °F)
40678-1		017446-000	A-B: 49.75 KΩ @ 25 °C (77 °F) B-C: 300 KΩ @ 25 °C (77 °F)
40678-4		023451-000	A-CONN: close on rise @ 60 °C ± 2.8 °C (140 °F ± 5 °F) C-CONN: close on rise @ 71 °C ± 2.8 °C (160 °F ± 5 °F) E-F: 1 KΩ ± 70 Ω @ 25 °C (77 °F)
40778-11	413351		A-B: close on rise 57 °C ± 2.8 °C (135 °F ± 5 °F) C-D: close on rise @ 71 °C ± 2.8 °C (160 °F ± 5 °F) E-F: 140 Ω @ 25 °C (77 °F)
40876-10		017446-000	A-B: 49.75 KΩ @ 25 °C (77 °F) B-C: 300 KΩ @ 25 °C (77 °F)
401076		019640-000	A-C: close on rise @ 71 °C ± 2.8 °C (160 °F ± 5 °F)
A2609-1	416275		A-B: close on rise @ 71 °C ± 2.8 °C (160 °F ± 5 °F) C-D: close on rise @ 57 °C ± 2.8 °C (135 °F ± 5 °F) E-F: 174 Ω ± 5 Ω @ 21-27 °C (70-80 °F) E-F: 200 Ω ± 0.5 Ω @ 59-61 °C (138--142 °F)
A26908	415537		A-B: close on rise @ 57 °C ± 2.8 °C (135 °F ± 5 °F) C-D: close on rise @ 71 °C ± 2.8 °C (160 °F ± 5 °F)
A275CH1	415826		A-C: opens on rise @ 71 °C ± 2.8 °C (160 °F ± 5 °F) A-B: 2043 Ω to 2717 Ω @ 21-27 °C (70-80 °F)
A40209-1	413175		B-C: close on rise @ 71 °C ± 2.8 °C (160 °F ± 5 °F) B-D: short circuit
A407CH	412299		A-B: close on rise @ 71 °C ± 2.8 °C (160 °F ± 5 °F) C-D: close on rise @ 71 °C ± 2.8 °C (160 °F ± 5 °F) D-E: short circuit
A407CH-3	412299		A-B: close on rise @ 71 °C ± 2.8 °C (160 °F ± 5 °F) C-D: close on rise @ 71 °C ± 2.8 °C (160 °F ± 5 °F) D-E: short circuit
A407CH9	410929	019756-000	A-C/D-F: 100 Ω @ 25 °C (77 °F) B-C/E-F: 30 KΩ @ 25 °C (77 °F)
A4076-21	412299		A-B: close on rise @ 71 °C ± 2.8 °C (160 °F ± 5 °F) C-D: close on rise @ 71 °C ± 2.8 °C (160 °F ± 5 °F) D-E: short circuit
A4078-12	412299		A-B: close on rise @ 71 °C ± 2.8 °C (160 °F ± 5 °F) C-D: close on rise @ 71 °C ± 2.8 °C (160 °F ± 5 °F) D-E: short circuit
B153CH1	415445		A-B: open on rise @ 71 °C ± 2.8 °C (160 °F ± 5 °F) C: middle point with 4.99 KΩ 1% resistor D-E: open on rise @ 8 °C ± 2.8 °C (46 °F ± 5 °F) D-F: open on rise @ 8 °C ± 2.8 °C (46 °F ± 5 °F) with 13 Ω resistor
B1513CH1	415445		A-B: open on rise @ 71 °C ± 2.8 °C (160 °F ± 5 °F) C: middle point with 4.99 KΩ 1% resistor D-E: open on rise @ 8 °C ± 2.8 °C (46 °F ± 5 °F) D-F: open on rise @ 8 °C ± 2.8 °C (46 °F ± 5 °F) with 13 Ω resistor

Table 1 - Sensor check

8-4. Vent valve test

NOTE: The Vent Valve Test is not necessary if the full set of used vent valves is replaced by a brand new one each year during the General Overhaul or when there is evidence of electrolyte overflow.

- This test should be done while the battery is on charge, just following the electrolyte leveling procedure. Check the operation of the vent-valve assembly as follows: Place the vent valve (160) with its O-ring into the vent valve adapter (T05) of the pressure test fixture.

- Immerse the vent-valve in water and slowly raise the air pressure.
- Test according to the table below, and change all vent valves if they do not pass the test.

test	Check
O-ring	No distortion, split or cracks
air pressure < 0.14 bar (2 psi)	Vent valve is closed
0.14 (2 psi) < air pressure < 0.7 bar (10 psi)	Vent valve opens

Table 2 - Vent valve test

9. Return to Service After Storage

When a battery is to be returned to service after storage, procedures should be followed as given in chapter [Storage \(including transportation\)](#).

PAGE INTENTIONALLY LEFT BLANK

ASSEMBLY

1. Introduction

This section covers basic battery assembly procedures. In all cases, when reassembling a battery, all components should be clean and dry.

2. Safety

Refer to chapter [Standard tools](#) in [SPECIAL TOOLS, FIXTURES, EQUIPMENT AND CONSUMABLES](#).

3. Equipment

3-1. Standard tools

Refer to chapter [Standard tools](#) in [SPECIAL TOOLS, FIXTURES, EQUIPMENT AND CONSUMABLES](#).

3-2. Special tools

When special tools are used in this chapter, they are identified by a code number listed in [SPECIAL TOOLS, FIXTURES, EQUIPMENT AND CONSUMABLES](#) chapter.

4. Battery Assembly

NOTE: All () part identification numbers herein are IPL Fig. 1 item numbers.

4-1. Installation of the vent valve (160)

Install the vent valve (160) with the special tool (T01).

4-2. Assembly of the battery

Lightly lubricate the terminals, the washers (120), the nuts (110) and the links (030 to 090) with M02 using a paintbrush.

NOTE: Some temperature sensors and/or heater blankets include components that require installation between cells and/or within the battery box. Ensure these items are installed properly prior to the first cell in each row being installed.

Place the sensor in the box (if applicable)

 **Some liners or spacers are slotted. Make sure the ventilating system of the box is unobstructed.**

Put the sensor, liners and spacers (200) in the box.

Insert the cells in the battery box making sure to maintain proper polarity. For easier installation, the center cell in each row should be the last one installed. Press firmly on the last cell in each row with a block of soft wood to seat it firmly in place.

Torque the lower nuts (110) to desired torque (refer to [FITS AND CLEARANCES](#) chapter).

Put the links (030 to 090), the washers (120) and the nuts (110) on the terminals.

Torque the nuts (110) to desired torque (refer to [FITS AND CLEARANCES](#) chapter)

Do an insulation test (refer to [Insulation check](#) chapter.)

Put the cover on the battery and attach it.

4-3. Fill in

Identification plate if the box (010) has been changed.

Log book.

PAGE INTENTIONALLY LEFT BLANK

FITS AND CLEARANCES

1. Introduction

The Specification Tables in this section are designed to provide basic information about each battery. The tables include the capacity rating necessary for charge and discharge procedures, the type of cells, the torque values for each cell type and important electrolyte volume and consumable volume information. A legend is provided below that contains the connector codes.

The torque values in these tables are “lube torque” values. The thread of the terminals and attaching nuts (or screws) should be lightly greased with a white, non-acid, petroleum jelly prior to assembly and applying torque.

2. Specification table

Type of connector	Characteristic
A	ARINC 404
B	Cannon CA.3102.R.24.9S.F80
C	Female threaded M8 x 1.25
D	EN2570 fig. 2 & 3
E	MIL B 83769 fig. 2
F	ISO 5064-2 ou MS 3509 style
G	Non Standard
H	MIL C 5015
I	Non Standard
J	Non Standard
K	Special, Contact Factory 72-19-4
L	Russian Standard

Table 1 - Connector type

Battery	Number of cells	Cells	Rated Capacity C1A	Dimension mm (in)	Weight kg (lbs)	Type of Connector	Lower Nut torque value N.m (lbf.in)	Upper Nut torque value N.m (lbf.in)	Electrolyte Level mm	Electrolyte water volume ml
19VO23KHB	19	VO3KHB	3	254x109x106 (10x4.3x4.2)	3.9 (8.6)	G	1 to 2 (17 to 18)	2.95 to 3.05 (22 to 30)	20	5
20VO3KHB	20	VO3KHB	3	254x109x106 (10x4.3x4.2)	4.1 (9)	G	1 to 2 (17 to 18)	2.95 to 3.05 (22 to 30)	20	5
20VO23KHB	20	VO3KHB	3	254x109x106 (10x4.3x4.2)		G	1 to 2 (17 to 18)	2.95 to 3.05 (22 to 30)	20	5
25HV01.1	25	HVO1.1	11	117.9x86.6x84.3 (4.64x3.41x3.32)	2.6 (5.8)	G	0.5 (4.4)	1 (8.7)	-	-
176CH	20	CVH170KA	17	322.6x163.1x200.0 (12.7x6.4x7.9)	18.1 (40.3)	F	4.5 to 5.5 (39.2 to 47.8)	7 to 9 (62 to 80)	20 MS	30
176CH6	20	CVH170KA	17			F	4.5 to 5.5 (39.2 to 47.8)	7 to 9 (62 to 80)	20 MS	30

FITS AND CLEARANCES

Battery	Number of cells	Cells	Rated Capacity C1A	Dimension mm (in)	Weight kg (lbs)	Type of Connector	Lower Nut torque value N.m (lbf.in)	Upper Nut torque value N.m (lbf.in)	Electrolyte Level mm	Electrolyte water volume ml
181CH	20	CVH180KH	18	310.0x167.0x200.0 (12.20x6.83x7.87)	18.5	G	4.5 to 5.5 (39.2 to 47.8)	9.6 (83.5)	20	12
187CH	20	CVH180KH	18	223.0x244.0x171.0 (8.78x9.61x6.73)	18.5	G	4.5 to 5.5 (39.2 to 47.8)	9.6 (83.5)	20	12
272CH1	20	CVH271KH	27	350x140.0x254.0 (13.79x5.51x10.0)	23.9 (52.7)	G	4.5 to 5.5 (39.2 to 47.8)	7 to 9 (62 to 80)	20	21
276CH	20	CVH271KH	27	254.0x198.0x224.0 (10.00x7.80x8.82)	25.2 (55.5)	G	4.5 to 5.5 (39.2 to 47.8)	7 to 9 (62 to 80)	20	21
276CH7	20	CVH271KH	27	276.0x250.0x226.0	25.5 (56)	F	4.5 to 5.5 (39.2 to 47.8)	7 to 9 (62 to 80)	20	21
276CH10	20	CVH271KH	27	276.0x250.0x226.0	25.4 (56)	F	4.5 to 5.5 (39.2 to 47.8)	7 to 9 (62 to 80)	20	21
276CH23	20	CVH271KH	27	276.0x250.0x22.06	25.4 (56)	F	4.5 to 5.5 (39.2 to 47.8)	7 to 9 (62 to 80)	20	21
277CH1	20	CVH271KH	27	254.0x198.0x224.0 (10.00x7.80x8.82)	25.2 (55.5)	G	4.5 to 5.5 (39.2 to 47.8)	7 to 9 (62 to 80)	20	21
310VX2	20	VXP310KH	31	420.0x216.0x250.0	32.6 (71.9)	G	4.5 to 5.5 (39.2 to 47.8)	7 to 9 (62 to 80)	20	25
340CD	20	CVD34KH	32	407.5x120.5x211.0 (16.04x4.74x8.31)	24.1 (53.1)	G	4.5 to 5.5 (39.2 to 47.8)	7 to 9 (62 to 80)	20	20
340CD-2	20	CVD34KH	32	407.5x120.5x211.0 (16.04x4.74x8.31)	24.1 (53.1)	G	4.5 to 5.5 (39.2 to 47.8)	7 to 9 (62 to 80)	20	20
345CD1	20	CVD34KH	32	407.5x120.5x211.0 (16.04x4.74x8.31)	24.1 (53.1)	G	4.5 to 5.5 (39.2 to 47.8)	7 to 9 (62 to 80)	20	20
435CH6	20	CVH430KA	43	301x262x253 (11.8x10.3x9.9)	36.3 (80)	F	4.5 to 5.5 (39.2 to 47.8)	7 to 9 (62 to 80)	20 MS	70
438CH2		CVH430KA	43			G	4.5 to 5.5 (39.2 to 47.8)	7 to 9 (62 to 80)	20 MS	70
A405CH3	20	CVH400KA	40	269.0x300.x262.0	35.0 (77.2)	D	4.5 to 5.5 (39.2 to 47.8)	12 to 14 (106 to 124)	20 MS	60
407CH2	20	CVH400KA	40	254.0x248.0x262.0 (10.00x9.76x10.31)	34.0 (75.0)	G	4.5 to 5.5 (39.2 to 47.8)	12 to 14 (106 to 124)	20 MS	60
407CH9	20	CVH400KA	40	254.0x248.0x262.0 (10.00x9.76x10.31)	35.4 (78.0)	F	4.5 to 5.5 (39.2 to 47.8)	12 to 14 (106 to 124)	20 MS	60
407CH11	20	CVH400KA	40	248.4x254.0x254.0 (9.78x10.00x254.0)	35.8 (79.0)	G	4.5 to 5.5 (39.2 to 47.8)	12 to 14 (106 to 124)	20 MS	60
407CH13	20	CVH400KA	40	248.4x254.0x254.0 (9.78x10.00x254.0)	34.6 (76.0)	G	4.5 to 5.5 (39.2 to 47.8)	12 to 14 (106 to 124)	20 MS	60
407CH19	20	CVH400KA	40	254.0x248.0x262.0 (10.00x9.76x10.31)	35.8 (79.0)	G	4.5 to 5.5 (39.2 to 47.8)	12 to 14 (106 to 124)	20 MS	60
437CH14	20	CVH400KA	40	248.4x254.0x254.0 (9.78x10.00x254.0)	34.6 (76.0)	G	4.5 to 5.5 (39.2 to 47.8)	12 to 14 (106 to 124)	20 MS	60
442CH2	20	CVH441KH	44	363.0x169.0x270.0 (6.65x10.63x81.6)	37.0 (81.6)	G	4.5 to 5.5 (39.2 to 47.8)	12 to 14 (106 to 124)	20	25
447CH1	20	CVH441KH	44	268.4x300.0x262.0	37.2 (82)	F	4.5 to 5.5 (39.2 to 47.8)	12 to 14 (106 to 124)	20	25
606	20	VP65K	6	366x125.5x155.5	9.1 (20.1)	I	4.5 to 5.5 (39.2 to 47.8)	7 to 9 (62 to 80)	12	8
615	19	VP65K	6	267.7x117.5x121.0	7.8 (17.1)	I	4.5 to 5.5 (39.2 to 47.8)	7 to 9 (62 to 80)	12	8

Battery	Number of cells	Cells	Rated Capacity C1A	Dimension mm (in)	Weight kg (lbs)	Type of Connector	Lower Nut torque value N.m (lbf.in)	Upper Nut torque value N.m (lbf.in)	Electrolyte Level mm	Electrolyte water volume ml
616	20	VP65K	6	267.7x117.5x121.0	8.0 (17.6)	I	4.5 to 5.5 (39.2 to 47.8)	7 to 9 (62 to 80)	12	8
653	21	VP65K	6	204.0x168.0x142.0	8.9 (19.6)	I	4.5 to 5.5 (39.2 to 47.8)	7 to 9 (62 to 80)	12	8
666	20	VP65K	6	177.0x174.0x158.0	8.2 (17.8)	I	4.5 to 5.5 (39.2 to 47.8)	7 to 9 (62 to 80)	12	8
1277	19	VP120KHMS	14	193.5x197.0x198.4 (7.62x7.75x7.81)	15.3x3 3.7	F	-	2.5 to 3.5 (22 to 31)	24	15
1277-1	19	VP120KHB	14	193.5x197.0x198.4 (7.62x7.75x7.81)	15.3x3 3.7	F	-	2.5 to 3.5 (22 to 31)	24 MS	15
1277-2	19	VP120KHB	14	193.5x197.0x198.4 (7.62x7.75x7.81)	15.3x3 3.7	F	-	2.5 to 3.5 (22 to 31)	24 MS	15
1277-3	19	VP120KHB	14	193.5x197.0x198.4 (7.62x7.75x7.81)	15.3x3 3.7	F	-	2.5 to 3.5 (22 to 31)	24 MS	15
1600	20	VO16KH	16	337.0x129.0x182.0	18.7 (41.2)	B	4.5 to 5.5 (39.2 to 47.8)	7 to 9 (62 to 80)	20	20
1606	20	VP160KM	16	370.0x118.6x204.5	17.3 (38.1)	C	4.5 to 5.5 (39.2 to 47.8)	7 to 9 (62 to 80)	20	20
1608	20	VHP170KH-3	17	370.0x118.6x207.5	17.8 (39.2)	C	4.5 to 5.5 (39.2 to 47.8)	7 to 9 (62 to 80)	20	20
1608-1	20	VHP170KH-3	17	370.0x120.1x207.5	17.7	I	4.5 to 5.5 (39.2 to 47.8)	7 to 9 (62 to 80)	20	20
1656	20	VP160KH	15	271.6x163.6x205.0	17.4 (38.3)	F	4.5 to 5.5 (39.2 to 47.8)	7 to 9 (62 to 80)	20	20
1656-1	20	VP160KH	15	271.6x163.6x205.0	17.4 (38.6)	F	4.5 to 5.5 (39.2 to 47.8)	7 to 9 (62 to 80)	20	20
1656-2	20	VP160KH	15	271.6x163.6x205.0	17.4 (38.6)	F	4.5 to 5.5 (39.2 to 47.8)	7 to 9 (62 to 80)	20	20
1656-5	20	VP160KH-SQ	15	271.6x163.6x205.0	17.9 (39.5)	F	4.5 to 5.5 (39.2 to 47.8)	7 to 9 (62 to 80)	33	8
1658	20	VHP170KH-3	17	271.6x163.6x205.0	17.8 (39.2)	F	4.5 to 5.5 (39.2 to 47.8)	7 to 9 (62 to 80)	20	20
1658-2	20	VHP170KH-3	17	271.6x163.6x205.0	17.8 (39.2)	F	4.5 to 5.5 (39.2 to 47.8)	7 to 9 (62 to 80)	20	20
1666	20	VP160KM	15	233.5x181.0x195.0	17.0	C	4.5 to 5.5 (39.2 to 47.8)	7 to 9 (62 to 80)	20	20
1666-1	20	VP160KM	15	233.5x181.0x195.0	17.0	C	4.5 to 5.5 (39.2 to 47.8)	7 to 9 (62 to 80)	20	20
1718	10	VHP170KH-3	17	206.0x126.0x187.0	10.7 (23.6)	G	4.5 to 5.5 (39.2 to 47.8)	7 to 9 (62 to 80)	20	20
1756	20	VP170KH	17	322.6x163.1x199.9	18.1	G	4.5 to 5.5 (39.2 to 47.8)	7 to 9 (62 to 80)	20	20
1756-2	20	VP170KH	17	322.6x163.1x199.9	18.1	G	4.5 to 5.5 (39.2 to 47.8)	7 to 9 (62 to 80)	20*	20
1758	20	VHP170KH-3	17	308.3x163.1x199.9	18.1	G	4.5 to 5.5 (39.2 to 47.8)	7 to 9 (62 to 80)	20	20
1811CH	20	CVH180SK	18	310.0x167.0x200.0 (12.2x6.83x6.7)	18.3 (40.4)	I	4.5 to 5.5 (39.2 to 47.8)	7 to 9 (62 to 80)	20	12
2026	20	VP200KHB	22	298.5x245.1x165.1 (11.75x9.65x6.50)	23.7 (52.5)	F	-	4 (40.0)	24	33

FITS AND CLEARANCES

Battery	Number of cells	Cells	Rated Capacity C1A	Dimension mm (in)	Weight kg (lbs)	Type of Connector	Lower Nut torque value N.m (lbf.in)	Upper Nut torque value N.m (lbf.in)	Electrolyte Level mm	Electrolyte water volume ml
2318	20	VHP230KA3	23	427.0x154.0x214.9	23.8	C	4.5 to 5.5 (39.2 to 47.8)	7 to 9 (62 to 80)	20	60
2353	19	VO23KH	23	252.6x194.6x228.0	23.2	E	4.5 to 5.5 (39.2 to 47.8)	7 to 9 (62 to 80)	20	21
2353-1	19	VO23KH	23	252.6x194.6x228.0	23.2	E	4.5 to 5.5 (39.2 to 47.8)	7 to 9 (62 to 80)	20	21
2371	20	VO23KH	23	249.2x268.4x224.0	25.4 (54)	F	4.5 to 5.5 (39.2 to 47.8)	7 to 9 (62 to 80)	20	21
2371-1	20	VO23KH	23	249.2x276.0x224.0	24.5 (54)	F	4.5 to 5.5 (39.2 to 47.8)	7 to 9 (62 to 80)	20	21
2371-2	20	VO23KH	23	249.2x276.0x224.0	24.5 (54)	F	4.5 to 5.5 (39.2 to 47.8)	7 to 9 (62 to 80)	20	21
2371-4	20	VO23KH	23	249.2x276.0x224.0	25.4 (54)	F	4.5 to 5.5 (39.2 to 47.8)	7 to 9 (62 to 80)	20	21
2371-5	20	VO23KH	23	249.2x276.0x224.0	24.9	F	4.5 to 5.5 (39.2 to 47.8)	7 to 9 (62 to 80)	20	21
2371-6	20	VO23KH	23	249.2x276.0x224.0	24.5 (54)	F	4.5 to 5.5 (39.2 to 47.8)	7 to 9 (62 to 80)	20	21
2371-7	20	VO23KH	23	249.2x276.0x224.0	24.5 (54)	F	4.5 to 5.5 (39.2 to 47.8)	7 to 9 (62 to 80)	20	21
2376	20	VP230KH	22	249.2x268.4x224.0	25.5 (56.2)	F	4.5 to 5.5 (39.2 to 47.8)	7 to 9 (62 to 80)	20	21
2376-1	20	VP230KH	22	249.2x276.0x224.0	25.5 (56.2)	F	4.5 to 5.5 (39.2 to 47.8)	7 to 9 (62 to 80)	20	21
2376-2	20	VP230KH	22	249.2x276.0x224.0	25.5 (56.2)	F	4.5 to 5.5 (39.2 to 47.8)	7 to 9 (62 to 80)	20	21
2376-3	20	VP230KH	22	249.2x276.0x224.0	25.5 (56.2)	F	4.5 to 5.5 (39.2 to 47.8)	7 to 9 (62 to 80)	20	21
2376-4	20	VP230KH	22	249.2x276.0x224.0	25.5 (56.2)	F	4.5 to 5.5 (39.2 to 47.8)	7 to 9 (62 to 80)	20	21
2376-7	20	VP230KH	22	249.2x276.0x224.0	25.5 (56.2)	F	4.5 to 5.5 (39.2 to 47.8)	7 to 9 (62 to 80)	20	21
2376-8	20	VP230KH	22	249.2x276.0x224.0	25.5 (56.2)	F	4.5 to 5.5 (39.2 to 47.8)	7 to 9 (62 to 80)	20	21
2376-9	20	VP230KH	22	249.2x276.0x224.0	25.5 (56.2)	F	4.5 to 5.5 (39.2 to 47.8)	7 to 9 (62 to 80)	20	21
2376-10	20	VP230KH	22	249.2x276.0x224.0	25.5 (56.2)	F	4.5 to 5.5 (39.2 to 47.8)	7 to 9 (62 to 80)	20	21
2378	20	VHP260KH-3	26	249.2x276.0x224.0	26 (57.3)	F	4.5 to 5.5 (39.2 to 47.8)	7 to 9 (62 to 80)	20	21
2386-1	20	VP200KHB	22	298.5x245.1x165.1 (11.75x9.65x6.50)	23.8 (52.5)	G	-	4 (40.0)	24	33
2500	20	VO25KA	25	497.0x129.0x182.0	27.2	H	4.5 to 5.5 (39.2 to 47.8)	7 to 9 (62 to 80)	20	60
2506-1	20	VP250KH	23	363.0x172.0x222.0	28.0	D	4.5 to 5.5 (39.2 to 47.8)	7 to 9 (62 to 80)	20	21
2506-2	20	VP250KH	23	363.0x172.0x222.0	28.0	D	4.5 to 5.5 (39.2 to 47.8)	7 to 9 (62 to 80)	20	21
2522	20	VO25KA-C	25	549.0x129.0x221.5	31.3	F	4.5 to 5.5 (39.2 to 47.8)	7 to 9 (62 to 80)	20	60

Battery	Number of cells	Cells	Rated Capacity C1A	Dimension mm (in)	Weight kg (lbs)	Type of Connector	Lower Nut torque value N.m (lbf.in)	Upper Nut torque value N.m (lbf.in)	Electrolyte Level mm	Electrolyte water volume ml
2608	20	VHP260KH-3	26	418.0x113.0x223.0	25.0	G	4.5 to 5.5 (39.2 to 47.8)	7 to 9 (62 to 80)	20	21
2708	20	VHP270KH-3	27	363.0x198.0x212.0	29.6	D	4.5 to 5.5 (39.2 to 47.8)	12 to 14 (106 to 124)	20	25
2708-1	20	VHP270KH-3	27	363.0x198.0x212.0	29.6	D	4.5 to 5.5 (39.2 to 47.8)	12 to 14 (106 to 124)	20	25
2778	20	VHP270KH-3	27	268.4x300.0x201.0 (10.5x11.8x7.9)	28.0	F	4.5 to 5.5 (39.2 to 47.8)	12 to 14 (106 to 124)	20	25
2778-2	20	VHP270KH-3	27	268.4x300.0x201.0 (10.5x11.8x7.9)	28.2 (62.2)	F	4.5 to 5.5 (39.2 to 47.8)	12 to 14 (106 to 124)	20	25
2778-5	20	VHP270KH-3	27	268.4x300.0x201.0 (10.5x11.8x7.9)	28.2	F	4.5 to 5.5 (39.2 to 47.8)	12 to 14 (106 to 124)	20	25
2778-10	20	VHP270KH-3	27	268.4x300.0x201.0 (10.5x11.8x7.9)	28.2	F	4.5 to 5.5 (39.2 to 47.8)	12 to 14 (106 to 124)	20	25
2778-15	20	VHP270KH-3	27	268.4x300.0x201.0 (10.5x11.8x7.9)	28.4	F	4.5 to 5.5 (39.2 to 47.8)	12 to 14 (106 to 124)	20	25
2778-18	20	VHP270KH-3	27	268.4x300.0x201.0 (10.5x11.8x7.9)	28.3	F	4.5 to 5.5 (39.2 to 47.8)	12 to 14 (106 to 124)	20	25
2778-20	20	VHP270KH-3	27	268.4x300.0x201.0 (10.5x11.8x7.9)	28.6	F	4.5 to 5.5 (39.2 to 47.8)	12 to 14 (106 to 124)	20	25
4000A1	20	VO40KH	40	420.0x216.0x275.0	36.5 (80.6)	D	4.5 to 5.5 (39.2 to 47.8)	12 to 14 (106 to 124)	20	25
4000A1-1	20	VO40KH	40	420.0x216.0x275.0	36.6 (80.6)	D	4.5 to 5.5 (39.2 to 47.8)	12 to 14 (106 to 124)	20	25
4002	20	VO40KH-C	40	420.0x216.0x270.0	36.3	D	4.5 to 5.5 (39.2 to 47.8)	12 to 14 (106 to 124)	20	25
4006A	20	VP400KH	36	363.0x169.0x270.0	37.3	D	4.5 to 5.5 (39.2 to 47.8)	12 to 14 (106 to 124)	20	25
4006A1-1	20	VP400KH	36	363.0x169.0x270.0	37.3	D	4.5 to 5.5 (39.2 to 47.8)	12 to 14 (106 to 124)	20	25
4008-1	20	VHP430KH-3	43	363.0x169.0x275.0	37.9	D	4.5 to 5.5 (39.2 to 47.8)	12 to 14 (106 to 124)	20	25
4010CH	20	CVH400KA	40	363.0x169.0x270.0 (14.29x6.65x10.63)	34.7 (76.3)	G	4.5 to 5.5 (39.2 to 47.8)	12 to 14 (106 to 124)	20 MS	60
4015CH-11	20	CVH400KA	40	254.0x248.0x262.0 (10.00x9.76x10.31)	36.0 (79.3)	G	4.5 to 5.5 (39.2 to 47.8)	12 to 14 (106 to 124)	20 MS	60
4017CH-1	20	CVH400KA	36	247.9x253.0x257.0 (9.76x9.96x10.11)	33.5 (73.7)	F	4.5 to 5.5 (39.2 to 47.8)	12 to 14 (106 to 124)	20 MS	60
4017CH-3	20	CVH400KA	36	247.9x253.0x257.0 (9.76x9.96x10.11)	36.4 (80.0)	F	4.5 to 5.5 (39.2 to 47.8)	12 to 14 (106 to 124)	20 MS	60
4050A1-1	20	VO40KH	40	268.4x300.0x262.0	35.5	E	4.5 to 5.5 (39.2 to 47.8)	12 to 14 (106 to 124)	20	25
4071	20	VO40KH	40	268.4x300.0x228.6	36.8 (81)	F	4.5 to 5.5 (39.2 to 47.8)	12 to 14 (106 to 124)	20	25
4071-1	20	VO40KH	40	268.4x300.0x262.0	36.0 (79.5)	F	4.5 to 5.5 (39.2 to 47.8)	12 to 14 (106 to 124)	20	25
4071-2	20	VO40KH	40	268.4x300.0x262.0	36.0	F	4.5 to 5.5 (39.2 to 47.8)	12 to 14 (106 to 124)	20	25
4071-3	20	VO40KH	40	268.4x300.0x262.0	36.2	F	4.5 to 5.5 (39.2 to 47.8)	12 to 14 (106 to 124)	20	25

FITS AND CLEARANCES

Battery	Number of cells	Cells	Rated Capacity C1A	Dimension mm (in)	Weight kg (lbs)	Type of Connector	Lower Nut torque value N.m (lbf.in)	Upper Nut torque value N.m (lbf.in)	Electrolyte Level mm	Electrolyte water volume ml
4071-10	20	VO40KH	40	268.4x300.0x262.0	36.7 (81)	F	4.5 to 5.5 (39.2 to 47.8)	12 to 14 (106 to 124)	20	25
4072	20	VO40KH-C	40	268.4x300.0x262.0	36.9	F	4.5 to 5.5 (39.2 to 47.8)	12 to 14 (106 to 124)	20	25
4076	20	VP400KH	36	268.4x300.0x262.0	37.8 (83.3)	F	4.5 to 5.5 (39.2 to 47.8)	12 to 14 (106 to 124)	20	25
4076-1	20	VP400KH	36	268.4x300.0x262.0	37.8 (83.3)	F	4.5 to 5.5 (39.2 to 47.8)	12 to 14 (106 to 124)	20	25
4076-2	20	VP400KH	36	268.4x300.0x262.0	37.7	F	4.5 to 5.5 (39.2 to 47.8)	12 to 14 (106 to 124)	20	25
4076-3	20	VP400KH	36	268.4x300.0x262.0	37.7	F	4.5 to 5.5 (39.2 to 47.8)	12 to 14 (106 to 124)	20	25
4076-8	20	VP400KH	36	268.4x300.0x262.0	37.7	F	4.5 to 5.5 (39.2 to 47.8)	12 to 14 (106 to 124)	20	25
4076-9	20	VP400KH	36	268.4x300.0x262.0	37.8 (83.3)	F	4.5 to 5.5 (39.2 to 47.8)	12 to 14 (106 to 124)	20	25
4076-11	20	VP400KH	40	268.4x300.0x262.0	37.8	F	4.5 to 5.5 (39.2 to 47.8)	12 to 14 (106 to 124)	20	25
4076-12	20	VP400KH	40	268.4x300.0x262.0	37.8	F	4.5 to 5.5 (39.2 to 47.8)	12 to 14 (106 to 124)	20	25
4076-13	20	VP400KH	40	268.4x300.0x262.0	37.8	F	4.5 to 5.5 (39.2 to 47.8)	12 to 14 (106 to 124)	20	25
4076-15	20	VP400KH	36	268.4x300.0x262.0	37.7	F	4.5 to 5.5 (39.2 to 47.8)	12 to 14 (106 to 124)	20	25
4076-16	20	VP400KH	36	268.4x300.0x262.0	37.8	F	4.5 to 5.5 (39.2 to 47.8)	12 to 14 (106 to 124)	20	25
4076-17	20	VP400KH	36	268.4x300.0x262.0	37.8	F	4.5 to 5.5 (39.2 to 47.8)	12 to 14 (106 to 124)	20	25
4076-19	20	VP400KH	36	268.4x300.0x262.0	37.7	F	4.5 to 5.5 (39.2 to 47.8)	12 to 14 (106 to 124)	20	25
4076-21	20	VP400KH	36	268.4x300.0x262.0	38 (83.7)	F	4.5 to 5.5 (39.2 to 47.8)	12 to 14 (106 to 124)	20	25
4077	19	VP400KH-MS	34	268.4x300.0x262.0	36.3 (80)	G	-	4 to 5 (35 to 44)	20	25
4078	20	VHP430KH-3	43	268.4x300.0x262.0	38.5	F	4.5 to 5.5 (39.2 to 47.8)	12 to 14 (106 to 124)	20	25
4078-1	20	VHP430KH-3	43	268.4x300.0x262.0	38.5	F	4.5 to 5.5 (39.2 to 47.8)	12 to 14 (106 to 124)	20	25
4078-5	20	VHP430KH-3	43	268.4x300.0x262.0	38.4	F	4.5 to 5.5 (39.2 to 47.8)	12 to 14 (106 to 124)	20	25
4078-6	20	VHP430KH-3	43	268.4x300.0x262.0	38.4	F	4.5 to 5.5 (39.2 to 47.8)	12 to 14 (106 to 124)	20	25
4078-9	20	VHP430KH-3	43	268.4x300.0x262.0	38.4	F	4.5 to 5.5 (39.2 to 47.8)	12 to 14 (106 to 124)	20	25
4078-10	20	VHP430KH-3	43	268.4x300.0x262.0	38.4	F	4.5 to 5.5 (39.2 to 47.8)	12 to 14 (106 to 124)	20	25
4078-11	20	VHP430KH-3	43	268.4x300.0x262.0	38.6 (85.1)	F	4.5 to 5.5 (39.2 to 47.8)	12 to 14 (106 to 124)	20	25
4078-12	20	VHP430KH-3SQ	43	268.4x300.0x262.0	38.5 (84.8)	F	4.5 to 5.5 (39.2 to 47.8)	12 to 14 (106 to 124)	38	10

Battery	Number of cells	Cells	Rated Capacity C1A	Dimension mm (in)	Weight kg (lbs)	Type of Connector	Lower Nut torque value N.m (lbf.in)	Upper Nut torque value N.m (lbf.in)	Electrolyte Level mm	Electrolyte water volume ml
4078-13	20	VHP430KH-3	43	268.4x300.0x262.0	38.5	F	4.5 to 5.5 (39.2 to 47.8)	12 to 14 (106 to 124)	20	25
4078-14	20	VHP430KH-3	43	268.5x300.0x262.0	38.4	F	4.5 to 5.5 (39.2 to 47.8)	12 to 14 (106 to 124)	20	25
4078-15	20	VHP430KH-3	43	268.4x300.0x262.0	38.5	F	4.5 to 5.5 (39.2 to 47.8)	12 to 14 (106 to 124)	20	25
4078-16	20	VHP430KH-3	43	268.4x300.0x262.0	38.6	F	4.5 to 5.5 (39.2 to 47.8)	12 to 14 (106 to 124)	20	25
4078-18	20	VHP430KH-3	43	268.4x300.0x262.0	38.4 (84.7)	F	4.5 to 5.5 (39.2 to 47.8)	12 to 14 (106 to 124)	20	25
4078-19	20	VHP430KH-1	43	268.4x300.0x262.0	38.4 (84.7)	F	4.5 to 5.5 (39.2 to 47.8)	12 to 14 (106 to 124)	20	25
4078-21	20	VHP430KH-3	43	268.4x300.0x262.0	38.4	F	4.5 to 5.5 (39.2 to 47.8)	12 to 14 (106 to 124)	20	25
4078-25	20	VHP430KH-3	43	268.4x300.0x262.0	38.4	F	4.5 to 5.5 (39.2 to 47.8)	12 to 14 (106 to 124)	20	25
4079	20	VHP370KA3	37	268.4x300.0x262.0	38.3	F	4.5 to 5.5 (39.2 to 47.8)	12 to 14 (106 to 124)	20	60
4079-1	20	VHP370KA3	37	268.4x300.0x262.0	38.9	F	4.5 to 5.5 (39.2 to 47.8)	12 to 14 (106 to 124)	20	60
4079-2	20	VHP370KA3	37	268.4x300.0x262.0	38.9	F	4.5 to 5.5 (39.2 to 47.8)	12 to 14 (106 to 124)	20	60
4079-4	20	VHP370KA3	37	268.4x300.0x262.0	38.9	F	4.5 to 5.5 (39.2 to 47.8)	12 to 14 (106 to 124)	20	60
4079-6	20	VHP370KA3	37	268.4x300.0x262.0	38.9	F	4.5 to 5.5 (39.2 to 47.8)	12 to 14 (106 to 124)	20	60
4079-9	20	VHP370KA3	37	268.4x300.0x262.0	38.9	F	4.5 to 5.5 (39.2 to 47.8)	12 to 14 (106 to 124)	20	60
4079-10	20	VHP370KA3	37	268.4x300.0x262.0	38.9	F	4.5 to 5.5 (39.2 to 47.8)	12 to 14 (106 to 124)	20	60
4080	20	VO40KH	40	252.6x246.6x262.2	37.2	D	4.5 to 5.5 (39.2 to 47.8)	12 to 14 (106 to 124)	20	25
4317CH1	20	CVH430KA	43	249.0x254.0x256.5 9.8x 10.0x10.1	37.7 (83)	F	4.5 to 5.5 (39.2 to 47.8)	7 to 9 (62 to 80)	20*	70
4410CH1	20	CVH441KH	44	420.0x216.0x270	36.4 (80.3)	F	4.5 to 5.5 (39.2 to 47.8)	12 to 14 (106 to 124)	38	10
6206	20	VP65K	6	372.5x124.5x161.5	9.2 (20.2)	I	4.5 to 5.5 (39.2 to 47.8)	7 to 9 (62 to 80)	12	8
8050	10	VO80KH	80	358.2x184.0x315.0 14.10x7.24x12.40	37.0	J	4.5 to 5.5 (39.2 to 47.8)	12 to 14 (106 to 124)	15	60
12150	20	VO23KH	23	255.6x199.6x225.6	23.4	G	4.5 to 5.5 (39.2 to 47.8)	7 to 9 (62 to 80)	20	21
12277	19	VP120KHB	15	193.5x197.0x198.4 (7.62x7.75x7.81)	15.4x3 4	G	-	2.5 to 3.5 (22 to 31)	24 MS	15
12277-1	19	VP120KHB	15	193.5x197.0x198.4 (7.62x7.75x7.81)	15.4x3 4	G	-	2.5 to 3.5 (22 to 31)	24 MS	15
12277-2	19	VP120KHB	15	193.5x197.0x198.4 (7.62x7.75x7.81)	15.4x3 4	G	-	2.5 to 3.5 (22 to 31)	24 MS	15
16100	20	VO16KH	16	337.0x129.0x182.0	18.7	B	4.5 to 5.5 (39.2 to 47.8)	7 to 9 (62 to 80)	20	20

FITS AND CLEARANCES

Battery	Number of cells	Cells	Rated Capacity C1A	Dimension mm (in)	Weight kg (lbs)	Type of Connector	Lower Nut torque value N.m (lbf.in)	Upper Nut torque value N.m (lbf.in)	Electrolyte Level mm	Electrolyte water volume ml
16106-1	20	VP160KM-SQ	16	356.5x132.0x204.5	17.1 (37.7)		4.5 to 5.5 (39.2 to 47.8)	7 to 9 (62 to 80)	33	8
16108-1	20	VHP170KH-3-SQ	17	356.0x125.0x204.5	17.7	I	4.5 to 5.5 (39.2 to 47.8)	7 to 9 (62 to 80)	33	8
16156	20	VP160KH	15	271.6x163.1x185.5	18.1	F	4.5 to 5.5 (39.2 to 47.8)	7 to 9 (62 to 80)	20	20
16156-1	20	VP160KH	15	271.6x163.1x185.5	18.1	F	4.5 to 5.5 (39.2 to 47.8)	7 to 9 (62 to 80)	20	20
16158	20	VHP170KH-3	17	273.8x165.1x187.0	18.7	I	4.5 to 5.5 (39.2 to 47.8)	7 to 9 (62 to 80)	20	20
16256	20	VP160KH	15	273.0x164.6x187.2	18.0	J	4.5 to 5.5 (39.2 to 47.8)	7 to 9 (62 to 80)	20	20
16256-3	20	VP160KH	15	273.0x164.6x187.2	18.0	J	4.5 to 5.5 (39.2 to 47.8)	7 to 9 (62 to 80)	20	20
16258	20	VHP170KH-3	17	271.6x215.0x181.0	18.3	I	4.5 to 5.5 (39.2 to 47.8)	7 to 9 (62 to 80)	20	20
16356	20	VP160KH	15	273.0x164.6x187.2	18.0	G	4.5 to 5.5 (39.2 to 47.8)	7 to 9 (62 to 80)	20	20
16556	20	VP160KM	16	267.0x179.5x183.5	19.1	G	4.5 to 5.5 (39.2 to 47.8)	7 to 9 (62 to 80)	20	20
20126	20	VP200KHB	22	298.5x245.1x165.1 11.75x9.65x6.50	23.8	G	-	4 (40.0)	24	33
20126-2	20	VP200KHB	22	298.5x245.1x165.1 11.75x9.65x6.50	23.5	G	-	4 (40.0)	24	33
20126-3	20	VP200KHB	22	298.5x245.1x165.1 11.75x9.65x6.5	23.5	G	-	4 (40.0)	24	33
23171-4	20	VO23KH-SQ	23	254.0x198.0x224.0	24.5	G	4.5 to 5.5 (39.2 to 47.8)	7 to 9 (62 to 80)	20	21
23175	19	VP230KH	22	249.2x276x224	23.7 (52.3)	F	4.5 to 5.5 (39.2 to 47.8)	7 to 9 (62 to 80)	20	21
23176	20	VP230KH	22	249.2x276x224	25 (55.1)	F	4.5 to 5.5 (39.2 to 47.8)	7 to 9 (62 to 80)	20	21
23376	20	VP230KH	22	254.0x198.0x224.0	25.5	G	4.5 to 5.5 (39.2 to 47.8)	7 to 9 (62 to 80)	20	21
23378	20	VHP260KH-3	26	254.0x198.0x224.0	25.8	G	4.5 to 5.5 (39.2 to 47.8)	7 to 9 (62 to 80)	20	21
23476	20	VP230KH	22	254.0x198.0x224.0	25.5	G	4.5 to 5.5 (39.2 to 47.8)	7 to 9 (62 to 80)	20	21
23478	20	VHP260KH-3	26	254.0x198.0x224.0	26.4	G	4.5 to 5.5 (39.2 to 47.8)	7 to 9 (62 to 80)	20	21
23491	20	VO23KH	23	276.0x250.0x224.0	24.7 (54.4)	G	4.5 to 5.5 (39.2 to 47.8)	7 to 9 (62 to 80)	20	21
23491-3	20	VO23KH	23	276.0x250.0x224.0	24.7 (54.4)	G	4.5 to 5.5 (39.2 to 47.8)	7 to 9 (62 to 80)	20	21
23491-4	20	VO23KH	23	276.0x250.0x224.0	23.6	G	4.5 to 5.5 (39.2 to 47.8)	7 to 9 (62 to 80)	20	21
23498-1	20	VHP260KH-3	26	276.0x250.0x224.0	25.6 (56.4)	G	4.5 to 5.5 (39.2 to 47.8)	7 to 9 (62 to 80)	20	21
23576	20	VP230KH	22	254.0x198.0x224.0	25.5	G	4.5 to 5.5 (39.2 to 47.8)	7 to 9 (62 to 80)	20	21

Battery	Number of cells	Cells	Rated Capacity C1A	Dimension mm (in)	Weight kg (lbs)	Type of Connector	Lower Nut torque value N.m (lbf.in)	Upper Nut torque value N.m (lbf.in)	Electrolyte Level mm	Electrolyte water volume ml
23576-1	20	VP230KH	22	252.5x195.3x222.3	25.0	G	4.5 to 5.5 (39.2 to 47.8)	7 to 9 (62 to 80)	20	21
23576-2	20	VP230KH	22	252.5x195.3x222.3	25.0	G	4.5 to 5.5 (39.2 to 47.8)	7 to 9 (62 to 80)	20	21
23676	20	VP230KH	24	457.2x114.6x224.0	25.9	G	4.3 to 5.2 (38 to 46)	9 to 9.9 (80 to 88)	20	21
23676-1	20	VP230KH	24	457.2x114.6x224.0	25.9	G	4.3 to 5.2 (38 to 46)	9 to 9.9 (80 to 88)	20	21
23676-2	20	VP230KH	24	457.2x114.6x224.0	25.9	G	4.3 to 5.2 (38 to 46)	9 to 9.9 (80 to 88)	20	21
23678-1	20	VHP260KH-3-SQ	26	254.0x198.0x224.0	26.1	G	4.5 to 5.5 (39.2 to 47.8)	7 to 9 (62 to 80)	33	8
23678-2	20	VHP260KH-3-SQ	26	254.0x198.0x224.0	25.5	G	4.5 to 5.5 (39.2 to 47.8)	7 to 9 (62 to 80)	33	8
23678-3	20	VHP260KH-3-SQ	26	254.0x198.0x224.0	26.7	G	4.5 to 5.5 (39.2 to 47.8)	7 to 9 (62 to 80)	33	8
25106	20	VP250KH	23	363.0x172.0x222.0	28.0	G	4.5 to 5.5 (39.2 to 47.8)	7 to 9 (62 to 80)	20	21
25106-2	20	VP250KH	23	363.0x172.0x222.0	28.0	G	4.5 to 5.5 (39.2 to 47.8)	7 to 9 (62 to 80)	20	21
26108-3	20	VHP260KH-3	26	301.5x174.0x230.0	24.5	G	4.5 to 5.5 (39.2 to 47.8)	7 to 9 (62 to 80)	20	21
26108-4	20	VHP260KH-3	26	301.5x174.0x230.0	24.5	G	4.5 to 5.5 (39.2 to 47.8)	7 to 9 (62 to 80)	20	21
26108-5	20	VHP260KH-3	26	301.5x174.0x230.0	24.5	G	4.5 to 5.5 (39.2 to 47.8)	7 to 9 (62 to 80)	20	21
26108-7	20	VHP260KH-3	26	301.5x174.0x230.0	24.5 (54)	G	4.5 to 5.5 (39.2 to 47.8)	7 to 9 (62 to 80)	20	21
26308-1	20	VHP260KH-3	26	281.0x166.0x229.0	25.4	G	4.5 to 5.5 (39.2 to 47.8)	7 to 9 (62 to 80)	20	21
26308-5	20	VHP260KH-3	26	281.0x166.0x229.0	25.4	G	4.5 to 5.5 (39.2 to 47.8)	7 to 9 (62 to 80)	20	21
26408-1	20	VHP260KH-3	26	281.0x166.0x229.0	25.4	G	4.5 to 5.5 (39.2 to 47.8)	7 to 9 (62 to 80)	20	21
26508	20	VHP260KH-3	26	466.0x170.0x245.2	26.8	J	4.5 to 5.5 (39.2 to 47.8)	7 to 9 (62 to 80)	20	21
26508	20	VHP260KH-3	26	466.0x170.0x245.2	26.8	J	4.5 to 5.5 (39.2 to 47.8)	7 to 9 (62 to 80)	20	21
26608-1	20	VHP260KH-3	26	476.6x188x245.2	26.9 (59.3)	J	4.5 to 5.5 (39.2 to 47.8)	7 to 9 (62 to 80)	20	21
26708	20	VHP260KH-3	26	464.0x170.0x245.2	26.9	J	4.5 to 5.5 (39.2 to 47.8)	7 to 9 (62 to 80)	20	21
26808		VHP260KH-3	26	482.0x170.0x236.8	26.9 (58.4)	J	4.5 to 5.5 (39.2 to 47.8)	7 to 9 (62 to 80)	20	21
27168-1	20	VHP270KH-3-SQ	27	360.5x170.0x202.0	28.3	G	4.5 to 5.5 (39.2 to 47.8)	12 to 14 (106 to 124)	38	10
27278	20	VHP270KH-3	27	254.0x248.0x201.0	28.3	G	4.5 to 5.5 (39.2 to 47.8)	12 to 14 (106 to 124)	20	25
27278-2	20	VHP270KH-3-SQKH-3	27	254.0x248.0x201.0	28.3	G	4.5 to 5.5 (39.2 to 47.8)	12 to 14 (106 to 124)	38	10

FITS AND CLEARANCES

Battery	Number of cells	Cells	Rated Capacity C1A	Dimension mm (in)	Weight kg (lbs)	Type of Connector	Lower Nut torque value N.m (lbf.in)	Upper Nut torque value N.m (lbf.in)	Electrolyte Level mm	Electrolyte water volume ml
27578-2	20	VHP270KH-3	27	254.0x248.0x201.0	28.3	G	4.5 to 5.5 (39.2 to 47.8)	12 to 14 (106 to 124)	20	25
40042	10	VOEC40KH	40	223.0x184.0x248.0	21.5	G	4.5 to 5.5 (39.2 to 47.8)	12 to 14 (106 to 124)	20	25
40100A	20	VO40KH	40	363.0x169.0x275.0	35.5	G	4.5 to 5.5 (39.2 to 47.8)	12 to 14 (106 to 124)	20	25
40100-1	20	VO40KH	40	363.0x169.0x275.0	35.5	G	4.5 to 5.5 (39.2 to 47.8)	12 to 14 (106 to 124)	20	25
40108-2	20	VHP430KH-3	43	363.0x169.0x270.0	37.8	G	4.5 to 5.5 (39.2 to 47.8)	12 to 14 (106 to 124)	20	25
40142	11	VOEC40KH	40	223.0x184.0x248.0	21.5	G	4.5 to 5.5 (39.2 to 47.8)	12 to 14 (106 to 124)	20	25
40152	11	VO40KH	40	233.7x231.2x290.6	11 (24.2)	G	4.5 to 5.5 (39.2 to 47.8)	12 to 14 (106 to 124)	20	25
40153	11	VP400KH	36	224.0x181.6x253.6	21.9	G	4.5 to 5.5 (39.2 to 47.8)	12 to 14 (106 to 124)	20	25
40176-10	20	VP400KH	36	254.0x248.0x262.0	37.4	G	4.5 to 5.5 (39.2 to 47.8)	12 to 14 (106 to 124)	20	25
40178	20	VHP430KH-3	43	340.0x248.0x262.0	41.0	G	4.5 to 5.5 (39.2 to 47.8)	12 to 14 (106 to 124)	20	25
40178-7	20	VHP430KH-3	43	340.0x248.0x262.0	41.0	G	4.5 to 5.5 (39.2 to 47.8)	12 to 14 (106 to 124)	20	25
40178-21	20	VHP430KH-3	43	254.0x248.0x262.0	38.4	G	4.5 to 5.5 (39.2 to 47.8)	12 to 14 (106 to 124)	20	25
40179-7	20	VHP370KA-3	37	268.4x304.8x264.0	38.5 (84.9)	G	4.5 to 5.5 (39.2 to 47.8)	12 to 14 (106 to 124)	20	60
40200	20	VO40KH	40	420.0x169.0x270.0	35.9	D	4.5 to 5.5 (39.2 to 47.8)	12 to 14 (106 to 124)	20	25
40200-1	20	VO40KH	40	420.0x169.0x270.0	36.6	D	4.5 to 5.5 (39.2 to 47.8)	12 to 14 (106 to 124)	20	25
40206-2	20	VP400KH	36	420.0x169.0x270.0	37.3	D	4.5 to 5.5 (39.2 to 47.8)	12 to 14 (106 to 124)	20	25
40208	20	VHP430KH-3	43	420.0x216.0x270.0	38.0	D	4.5 to 5.5 (39.2 to 47.8)	12 to 14 (106 to 124)	20	25
40208-1	20	VHP430KH-3	43	420.0x216.0x270.0	38.2 (84.1)	D	4.5 to 5.5 (39.2 to 47.8)	12 to 14 (106 to 124)	20	25
40208-2	20	VHP430KH-3	43	420.0x216.0x270.0	38.2 (84.1)	D	4.5 to 5.5 (39.2 to 47.8)	12 to 14 (106 to 124)	20	25
40208-4	20	VHP430KH-3	43	420.0x216.0x270.0	38.2 (84.1)	D	4.5 to 5.5 (39.2 to 47.8)	12 to 14 (106 to 124)	20	25
40208-5	20	VHP430KH-3	43	420.0x216.0x270.0	38.2 (84.1)	D	4.5 to 5.5 (39.2 to 47.8)	12 to 14 (106 to 124)	20	25
40208-6	20	VHP430KH-3	43	420.0x216.0x270.0	38.3	D	4.5 to 5.5 (39.2 to 47.8)	12 to 14 (106 to 124)	20	25
40208-7	20	VHP430KH-3SQ	43	420.0x216.0x270.0	38.3	D	4.5 to 5.5 (39.2 to 47.8)	12 to 14 (106 to 124)	38	10
40209-2	20	VHP370KA3	37	412.0x209.0x230.0	37.0	D	4.5 to 5.5 (39.2 to 47.8)	12 to 14 (106 to 124)	20	60
40253	11	VP340KA	34	224.0x181.6x254.5	21.0	G	4.5 to 5.5 (39.2 to 47.8)	12 to 14 (106 to 124)	20	55

Battery	Number of cells	Cells	Rated Capacity C1A	Dimension mm (in)	Weight kg (lbs)	Type of Connector	Lower Nut torque value N.m (lbf.in)	Upper Nut torque value N.m (lbf.in)	Electrolyte Level mm	Electrolyte water volume ml
40278-2	20	VHP430KH-3SQ	43	254.0x248.0x262.0	38.5	G	4.5 to 5.5 (39.2 to 47.8)	12 to 14 (106 to 124)	38	10
40278-14	20	VHP430KH-3	43	300.0x268.4x262.0	38.4 (84.7)	D	4.5 to 5.5 (39.2 to 47.8)	12 to 14 (106 to 124)	20	25
40300	20	VO40KH-3	40	363.0x169.0x270.0	33.0	J	4.5 to 5.5 (39.2 to 47.8)	12 to 14 (106 to 124)	20	25
40306	20	VP400KH-SQ	36	363.0x169.0x270.0	37.0	D	4.5 to 5.5 (39.2 to 47.8)	12 to 14 (106 to 124)	20	10
40342	10	VOEC40KH	40	219.0x166.0x250.0	18.5	G	4.5 to 5.5 (39.2 to 47.8)	12 to 14 (106 to 124)	20	25
40353	11	VP380KH	42	224.0x181.6x254.5	21.0	G	4.5 to 5.5 (39.2 to 47.8)	12 to 14 (106 to 124)	20	25
40371	20	VOEC40KH	40	253.0x247.5x249.0	36.0	G	4.5 to 5.5 (39.2 to 47.8)	12 to 14 (106 to 124)	20	25
40376	20	VP400KH	36	303.0x247.4x262.0	37.7	G	4.5 to 5.5 (39.2 to 47.8)	12 to 14 (106 to 124)	20	25
40378	20	VHP430KH-3	43	277.6x213.9x256.0	36.3	G	4.5 to 5.5 (39.2 to 47.8)	12 to 14 (106 to 124)	20	25
40379	20	VHP370KH-3-SQ	37	254.0x248.0x262.0	38.4	G	4.5 to 5.5 (39.2 to 47.8)	12 to 14 (106 to 124)	38	25
40408	20	VHP430KH-3	43	363.0x169.0x270.0	37.9	D	4.5 to 5.5 (39.2 to 47.8)	12 to 14 (106 to 124)	20	25
40478-1	20	VHP430KH-3	43	254.0x248.3x249.0	36.6	G	4.5 to 5.5 (39.2 to 47.8)	12 to 14 (106 to 124)	20	25
40508-1	20	VHP430KH-3SQ	43	398.5x169.0x265.0	38.3	G	4.5 to 5.5 (39.2 to 47.8)	12 to 14 (106 to 124)	38*	10
40576	20	VP400KH-AC	36	254.0x248.0x262.0	36.8	G	4.5 to 5.5 (39.2 to 47.8)	12 to 14 (106 to 124)	24 MS	25
40576-3	20	VP400KH-AC	36	254.0x248.0x262.0	36.8	G	4.5 to 5.5 (39.2 to 47.8)	12 to 14 (106 to 124)	24 MS	25
40576-14	20	VP400KH-AC	36	254.0x248.0x262.0	36.8	G	4.5 to 5.5 (39.2 to 47.8)	12 to 14 (106 to 124)	24 MS	25
40578-1	20	VHP430KH-3	43	254.0x248.0x248.8	37.4	G	4.5 to 5.5 (39.2 to 47.8)	12 to 14 (106 to 124)	20	25
40676	20	VP400KH-AC	36	254.0x247.7x266.7	36.3	G	4.5 to 5.5 (39.2 to 47.8)	12 to 14 (106 to 124)	24 MS	25
40678	20	VHP430KH-3	43	254.0x248.0x262.0	38.6	G	4.5 to 5.5 (39.2 to 47.8)	12 to 14 (106 to 124)	20	25
40678-1	20	VHP430KH-3	45	254.0x248.0x262.0	38.6	G	4.5 to 5.5 (39.2 to 47.8)	12 to 14 (106 to 124)	20	25
40678-4	20	VHP450KH-1	45	254.0x248.0x262.0	38.4	G	4.5 to 5.5 (39.2 to 47.8)	12 to 14 (106 to 124)	20	25
40776	20	VP400KH-AC	40	254.0x248.4x262.0	37.6	G	4.5 to 5.5 (39.2 to 47.8)	12 to 14 (106 to 124)	24 MS	25
40778-11	20	VHP430KH-3	43	254.0x248.0x262.0 (10.00x9.76x10.31)	38.6	G	4.5 to 5.5 (39.2 to 47.8)	12 to 14 (106 to 124)	20	25
40876	20	VP400KH	36	252.0x246.0x260.0	37.0	G	4.5 to 5.5 (39.2 to 47.8)	12 to 14 (106 to 124)	20	25
40876-10	20	VP400KH	36	252.0x246.0x260.0	37.0	G	4.5 to 5.5 (39.2 to 47.8)	12 to 14 (106 to 124)	20	25

FITS AND CLEARANCES

Battery	Number of cells	Cells	Rated Capacity C1A	Dimension mm (in)	Weight kg (lbs)	Type of Connector	Lower Nut torque value N.m (lbf.in)	Upper Nut torque value N.m (lbf.in)	Electrolyte Level mm	Electrolyte water volume ml
401076	20	VP400KH-AC	40	254.0x247.5x264.8	36.3	G	4.5 to 5.5 (39.2 to 47.8)	12 to 14 (106 to 124)	24 MS	25
401176-10	20	VP400KH	40	254.0x247.5x260.0	37.0	G	4.5 to 5.5 (39.2 to 47.8)	12 to 14 (106 to 124)	20	25
A185CH	20	CVH180KH-SQ	18	253.0x197.0x162.0 (9.9x7.8x6.4)	18.3 (40.4)	I	4.5 to 5.5 (39.2 to 47.8)	7 to 9 (62 to 80)	26	9
A275CH1	20	CVH271KH-SQ	27	254.0x265.5x230.0	23.7 (52.3)	F	4.5 to 5.5 (39.2 to 47.8)	7 to 9 (62 to 80)	33	8
A407CH-3	20	CVH400KH-SQ	40	300.0x269.0x280.0 (11.8x10.6x11.0)	34.3 (75.7)	D	4.5 to 5.5 (39.2 to 47.8)	12 to 14 (106 to 124)	38 MS	25
A408CH	20	CVH400KH-SQ	40	252.6x246.6x266.6 (9.94x9.71x10.50)	35.1 (77.4)	D	4.5 to 5.5 (39.2 to 47.8)	12 to 14 (106 to 124)	38 MS	25
A447CH-12	20	CVH441KH-SQ	44	254.0x248.0x262.0 (10.00x9.76x10.31)	36.6 (80.7)	G	4.5 to 5.5 (39.2 to 47.8)	12 to 14 (106 to 124)	38	10
A2609-1	20	VHP260KH-3-SQ	26	-	21.5 (47.4)	G	4.5 to 5.5 (39.2 to 47.8)	7 to 9 (62 to 80)	33	8
A26908	20	VHP260KH-3-SQ	26	-	27.7 (61.1)	G	4.5 to 5.5 (39.2 to 47.8)	7 to 9 (62 to 80)	33	8
A4078-12	20	VHP430KH-3SQ	43	268.4x300x262	38.5 (84.8)	F	4.5 to 5.5 (39.2 to 47.8)	12 to 14 (106 to 124)	38	10
A40209	20	VHP370KH-3-SQ	37	363.0x169.0x270.0	37.9	D	4.5 to 5.5 (39.2 to 47.8)	12 to 14 (106 to 124)	38	25
A40209-1	20	VHP370KH-3-SQ	37	363.0x169.0x270.0	37.9	D	4.5 to 5.5 (39.2 to 47.8)	12 to 14 (106 to 124)	38	25
B153CH1	20	CVH150KH	15	364.0x138.5x196.0	15.3 (33.7)	J	4.5 to 5.5 (39.2 to 47.8)	7 to 9 (62 to 80)	20	15
B1513CH1	20	CVH150KH	15	364.0x138.5x196.0	15.3 (33.7)	J	4.5 to 5.5 (39.2 to 47.8)	7 to 9 (62 to 80)	20	15
GB170	19	KO7.5KH	7	251.6x117.3x117.5 (9.91x4.63x4.63)	7.6x16. 8	J	1.4 (12.15)	1.4 (12.15)	17	8

Table 2 - Battery fits and clearances

MS : Indicates bayonet type vent valves

SPECIAL TOOLS, FIXTURES, EQUIPMENT AND CONSUMABLES

1. Introduction

This chapter is divided into two parts:

- The first part provides the list of special tools, fixtures and equipment needed to do the steps listed in the other chapters.
- The second part provides the listing of consumable materials used in this manual.

All listed items are identified in this manual by a standard code number:

- Txx for tools, fixtures and equipment,
- Mxx for consumable materials.









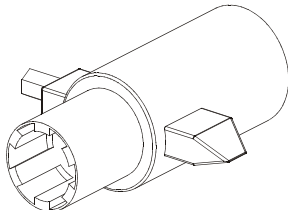

2. Standard tools

The following items are recommended to do the procedures described in this manual. When necessary, equivalent substitutes may be used.

- Constant Current Power Unit (0-60 A)
- Constant Current Load Bank (0-60 A)
- Megohmmeter (0-50 M Ω @ 250 V continuous)
- Precision Multimeter (Volt, Ω , mA)
- Torque Wrench (Fully insulated) 0-15 N.m (0-133 lbf.in)
- Standard mechanic's tools.
- Safety gloves.
- Protective goggles.
- Safety shoes.
- Eye wash.
- Protective apron.
- Stiff bristle brush (non-metallic)
- Small paintbrush (non-metallic)
- Dry, compressed air source [less than 1.4 bar (20 psi)]
- Soft, clean cloth (at least two required)

3. Special tools**NOTE: Equivalent tools can be used.**

CODE	DESCRIPTION	F6177 P/N	V09052 P/N
T01	Universal vent wrench 	413876	093365-000

CODE	DESCRIPTION	F6177 P/N	V09052 P/N
T02	Syringe assembly (with nozzle) 		
	Nozzle Length in millimeters		
	12 	416228	020915-002
	15 	416229	
	20 for M8 valves 	416231	020915-004
	20 for bayonet type vent valve (MS) 	416232	020916-001
	24 	416233	
	24 for bayonet type vent valve (MS) 	-	020916-002
	33 	416235	
	38 for M8 valves 	416236	
	38 for bayonet type vent valve (MS) 	416331	

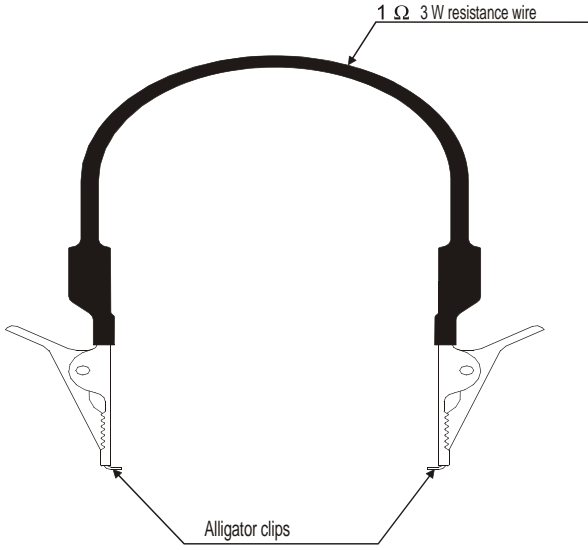
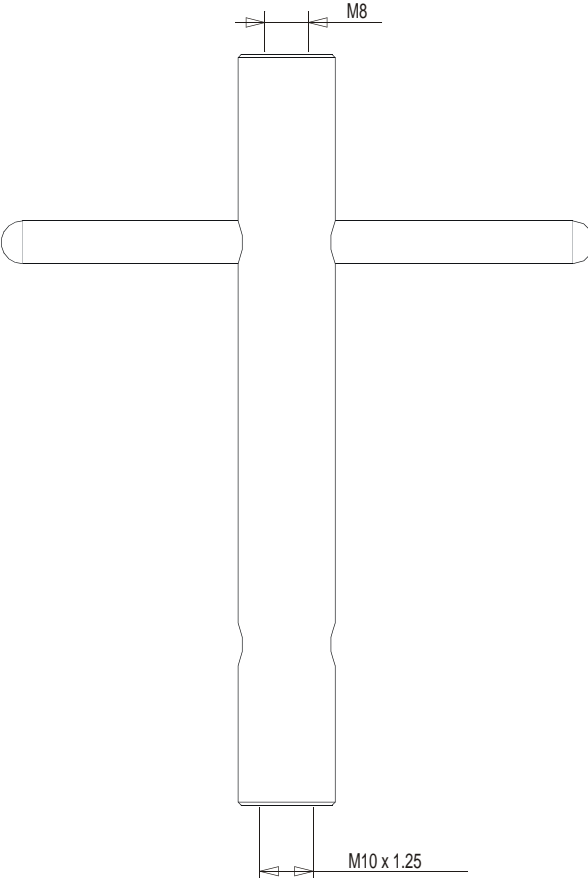
CODE	DESCRIPTION	F6177 P/N	V09052 P/N
T03	<p>1 Ω 3 W equalizing resistors</p> 	164829	
	Shorting clip	-	022069-000
T04	<p>Universal cell extraction tool</p> 	416159	

CODE	DESCRIPTION	F6177 P/N	V09052 P/N
T05	Vent valve adapter for M8 valve 	-	025098-000
	Vent valve adapter for bayonet type vent valve (MS) 	-	024398-000

Table 1 - Special tools

3-1. Tool kit

A special toolkit is available from Saft with the P/N 416161 containing all special tools T01, T02 except for the 38 bayonet type vent valve (MS) (P/N 416331), T03, and T04. A special version for CEI60952 type A connector is available with P/N 416160 .

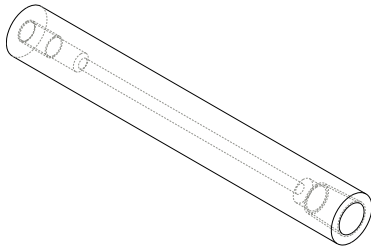
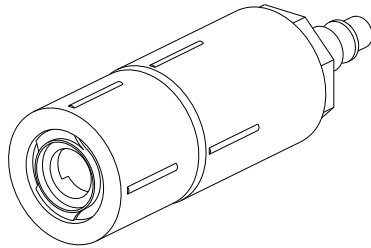

**Tool Kit
Figure 1**

4. Consumables

NOTE:Equivalent alternatives can be used for list items.

This paragraph describes the consumables used in the OMM.

CODE	DESIGNATION PARTNUMBER AND SPECIFICATION	MANUFACTURER OR SUPPLIER (NAME, ADDRESS, CODE)
M01	Distilled or deionized water clear, colourless, odorless while boiling, resistivity > 30 kΩ/cm 5 < pH < 7 Absence of organic and reducing substances. Reducing agent content (expressed in weight of oxygen) < 30 mg/l (test with permanganate). Total of ions SO ₄ ²⁻ , Cl ⁻ < 10 mg/l Dry extract < 15 mg/l Silicium in SiO ₂ < 15 mg/l	Local vendor
M02	Neutral petroleum jelly Density @ 60°C (140°F) Range = 0.840 - 0.866 Kg/L Melting Point Range = 46°C - 52°C (115°F - 126°F) Acidity/Alkalinity = Neutral to Litmus	Mineral vaseline OTAN: S 743 F: AIR 3565 US: VV-P-236/A UK: DEF 2333
M03	Soap	Local vendor

Table 2 - List of consumables

ILLUSTRATED PARTS LIST

1. Detailed part list

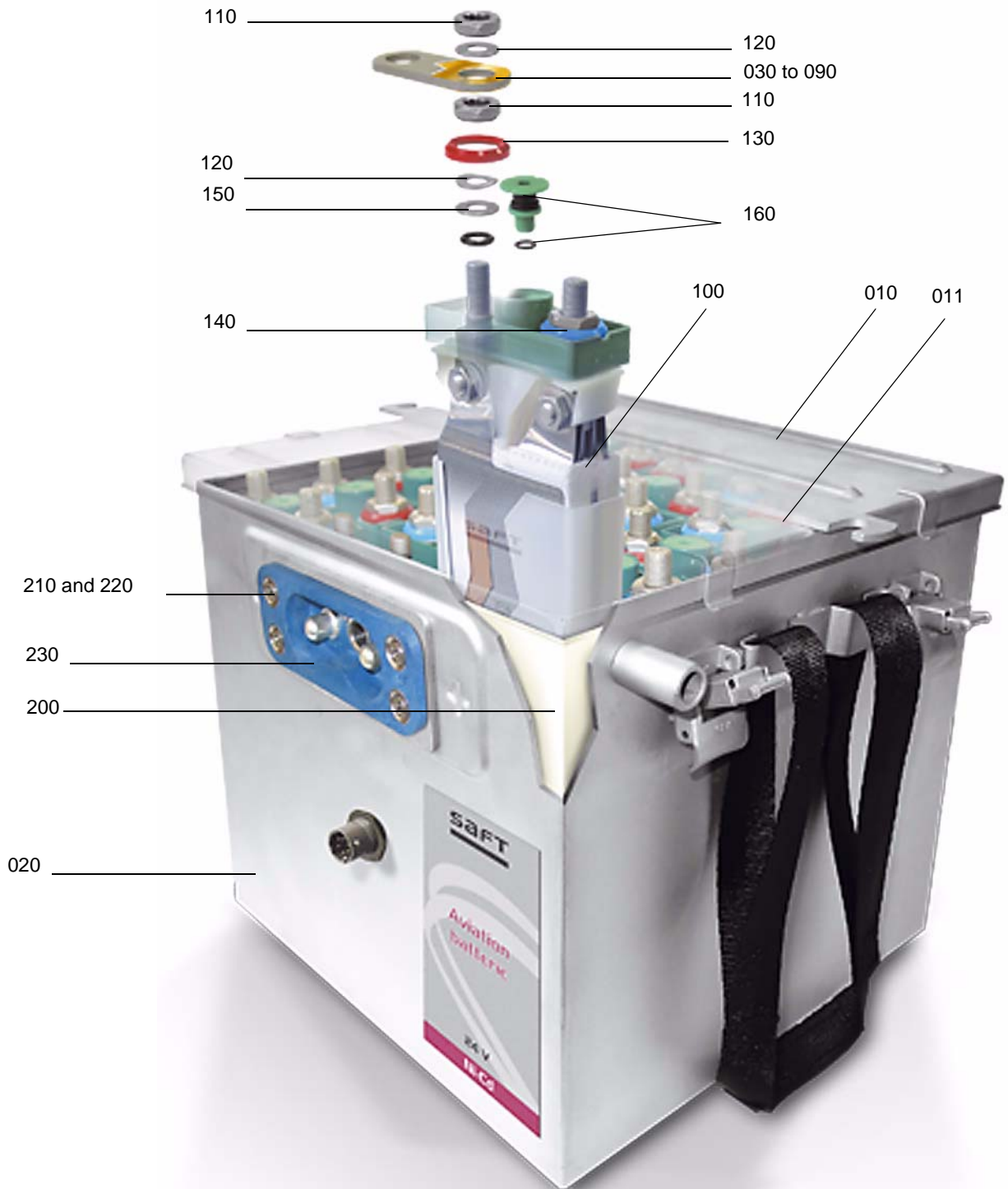

Nickel-Cadmium Aircraft Battery
Figure 1

ILLUSTRATED PARTS LIST

Figure Number	Item Number	Airline Stock Number	Nomenclature							Quantity per Battery
			1	2	3	4	5	6	7	
1			BATTERY							
	010		.	Cover						1
	011		..	Gasket cover						1
	020		.	Box						1
	030		.	Link						
	040		.	Link						
	050		.	Link						
	060		.	Link						
	070		.	Link						
	080		.	Link						
	090		.	Link						
	095		.	Link						
	100		.	Cell						
	110		..	Nut						
	120		..	Washer, spring						
	130		..	Washer, positive polarity						
	140		..	Washer, negative polarity						
	150		..	Washer, flat						
	160		..	Vent valve assembly						
	190		.	Washer						
	200		.	Liner-spacer kit						
	210		.	Screw						
	220		.	Washer						
	230		.	Connector, complete						
	-240		.	O-ring						

This example of an Illustrated Parts List (IPL) is for general reference only.

Table 1 - Description of parts shown in figure 1

2. Battery part list

Battery	P/N reference	Cell	010 +020	010	020	200	210	220	230	240
19VO3KHB	414547	VO3KHB	414550	414557	414551	414562	413207	-	414570	-
20VO3KHB	414548	VO3KHB	414550	414557	414551	414562	413207	-	414570	-
176CH	025897-000	CVH170KA	-	016204-001	025915-000	-	013616-000	-	021791-000	009384-000
176CH6		CVH171KH	-	015722-000	025931-000	020874-000	093616-000	-	021741-000	009384-000
181CH	414254	CVH180KH	414288	414287	414284	414289	100431	100430	410251	100713
272CH1	415188	CVH271KH	415910	415912	415911	415202	-	-	414482	-
276CH7	415779	CVH271KH	415782	114318	415781	415783	100431	100430	102226	-
276CH10	415957	CVH271KH	415782	114318	415781	411827	100431	100430	102226	-
276CH23	415959	CVH271KH	416104	114318 015697-00	415960 025944-000	411827 020795-000	100431 093616-000	100430	102226 021741-000	-
345CD1	415241	CVD34KH	415304			415345	100431	100430	411075	-
405CH3	415956	CVH400KA	416011	413791	416012	413714	100431	100430	102392 021740-000	-
407CH5	415007	CVH400KA	415786	413791	415784	413714	100431	100430	102392 021740-000	100713
407CH9	024947-000	023413-000	-	015599-000	024949-000	022369-000	092178-000	091924-000	022078-000	009384-000
435CH6	416381	CVH430KA	416093				100431	100430	102392 021740-000	415059
437CH14	025776-000	CVH430KA	-	025778-000	025777-000		093616-000	009384-000	-	-
438CH2		CVH430KA	-	025396-000	025932-000	019919-000	093616-000	-	021740-000	009384-000
447CH1	415538	CVH441KH	412733	114278	412744	411424	100431	100430	102392 021740-000	100713
505CH3	415907	CVH500KA	-	415014	415106	415016	100431	100430	415156	415059
606	410689	VP65K	165701	165699	120148	411684	120170	100166	163292	-
615	410766	VP65K	167738	167726	167722	-	-	167520	167727	-
616	411146	VP65K	411147	411306	411151	411343	108045	410456	411303	-
653	167327	VP65K	410181	-	-	412656	108045	107644	160809	-
666	410705	VP65K	415705	410707	410706	415659	-	-	-	-
1277	100504	VP120KHMS	114453	100514	100505	411707	102129	78011	102057	100713
1277-1	115944	VP120KHB	118105	100514	118101	411707	100523	100430	102057	100713
1277-3	414140	VP120KHB	118105	100514	118101	411707	100523	100430	102057	100713
1600	103275	VO16KH	161093	103281	103276	412635	102037	102036	43120	-
1606	161185	VP160KM	410825	410823	410822	412230	-	-	-	-
1608	410407	VP170KH-3								
1608-1	410075	VP170KH-3	410825	410824	410822	412230	-	-	-	-
1656-1	114769	VP160KH	167601	106337	115737	410996	100523	100430	102226	-
1656-2	164747	VP160KH	167601	106316	115737	410996	100523	100430	102226	-
1656-5	410378	VP160KH-SQ	167601	106316	115737	410996	100523	100430	102226	-
1658	410385 020770-000	VHP170KH-3	114607	106337	106312	410996	100523	100430	102226	-
1658-2	410231	VHP170KH-3	167601	106316	115737	412637	100523	100430	102226	-
1666-1	167598	VP160KM	166893	166892	166815	411226	-	-	-	-
1718	414445	VP170KH--3	414468	414469	414446	414456	100431	100430	102226	100713
2353-1	114733	VO23KH	114571	114910	114572	412648	-	-	100897	-
2371	100429	VO23KH		100421	100419	411425	100431	100430	160510	-

ILLUSTRATED PARTS LIST

Battery	P/N reference	Cell	010 +020	010	020	200	210	220	230	240
2371-1	114763	VO23KH	115917	114318	115731	411940	100431	100430	102226	100713
2371-2	162899	VO23KH	115917	114318	115731	411940	100431	100430	102226	100713
2371-5	411247	VO23KH	115917	114318	115731	412649	100431	100430	102226	100713
2371-6	410696	VO23KH-SQ	115917	114318	115731	411827	100431	100430	102226	100713
2371-7	411777	VO23KH-SQ	411792	114318	411791	411425	100431	100430	102226	100713
2376	105408	VP230KH	114301	114318	100419	411425	100431	100430	102226	100713
2376-1	114765	VP230KH	115917	114318	115731	411940	100431	100430	102226	100713
2376-2	165603	VP230KH	115917	114318	115731	412649	100431	100430	102226	100713
2376-4	410862	VP230KH	410536	114318	410535	411426	100431	100430	102226	100713
2376-7	412942	VP230KH	410536	114318	410535	413459	100431	100430	102226	100713
2376-8	413465	VP230KH	413074	114318	413077	412642	100431	100430	102226	100713
2378	166851	VHP260KH-3	166863	166593	100419	411225	100431	100430	102226	100713
2500	103261	VO25KA	161010	102001	103262	412651	102013	100433	43124	-
2506-1	116129	VP250KH	116128	115593	116127	412652	116386	126387	BAC102	-
2506-2	412670	VP250KH	412698	115593	412699	413355	116386	116367	BAC102	-
2522	412920	VO25KAC	114363	103388	103377	412458	100431	100430	102226	-
2708-1	411621	VHP270KH-3	411754	165888	411755	411757	160699 [3] 101699 [1]	-	BAC102	-
2708-2	412212	VHP270KH-3	412218	165888	412217	412213	160699 [3] 101699 [1]	-	BAC102	-
2778	166130	VHP270KH-3	166259	166260	166316	411428	100431	100430	102392 021740-000	100713
2778-2	410001	VHP270KH-3	411287	102295	166549	411941	100431	100430	102392 021740-000	100713
2778-5	410868	VHP270KH-3	410867	114300	410866	411941	100431	100430	102392 021740-000	100713
2778-10	413211	VHP270KH-3	166457	166260	412158	411941	100431	100430	102392 021740-000	100713
2778-15	413329	VHP270KH-3	411287	114300	166459	411941	100431	100430	102392 021740-000	100713
2778-18	413658	VHP270KH-3	413816	114300	413826	413817	100431	100430	102392 021740-000	100713
4000A1	114099	VO40KH	018017	102865	100857	412653	116386	116387	BAC102	-
4002	414162	VO40KHC	112804	113915	106516	412653	116386	116387	BAC102	-
4006A	162041	VP400KH	112804	106521	106516	412653	116386	116387	BAC102	-
4006A-1	162707 162708	VP400KH	116103	106521	116102	412653	116386	116387	BAC102	-
4008-1	411248	VHP430KH-3	116103	113995	116102	412653	116386	116387	BAC102	-
4017CH-1	023789-000	CVH400KA		015924	024050-000		015579-000	015577-000	022078-000	
4050A1-1	114760	VO40KH	115991	102922	115992	412657	-	-	100897	-
4071	102390 016592-000	VO40KH	114278	114300 015599-000	102391	411424	100431 093616-000	100430	102392 021740-000	100713 009384-000
4071-1	114725	VO40KH		114300 015599-000	115732		100431	100430	160510	100713 009384-000
4071-2	166731 019513-000	VO40KH	115963	114300 015599-000	115732 021701-000	411424 019919-000	100431 093616-000	100430	102392 021740-000	100713 009384-000
4071-3	023044-000	VO40KH	-	015599-000	023058-000	019919-000	093616-000	-	021740-000	009384-000
4072	412931	VO40KHC	114278	114300	102391	411424	100431	100430	102392 021740-000	100713

Battery	P/N reference	Cell	010 +020	010	020	200	210	220	230	240
4076-2	160229	VP400KH	115963	114300	161088	411424	100431	100430	102392 021740-000	100713
4076	102446	VP400KH	114278	114300	102391	411424	100431	100430	102392 021740-000	100713
4076-1	115967	VP400KH	115963	114300	115732	411424	100431	100430	102392 021740-000	100713
4076-3	117926 017445-000	VP400KH	117927	114300 015599-000	117928 021495-000	411424 019919-000	100431 093616-000	100430	102392 021740-000	100713 009384-000
4076-9	167556	VP400KH	167711	102295	167633	411424	100431	100430	102392 021740-000	-
4076-11	019368-000 023515-000	VP400KH	-	015599-000	021500-000	019919-000	093616-000	-	021740-000	009384-000
4076-12	019500-000	VP400KH	-	015599-000	021501-000	019919-000	093616-000	-	021740-000	009384-000
4076-13	023322-000	VP400KH	-	021003-000	023316-000	019919-000	093616-000	-	021740-000	009384-000
4076-15	412786 024555-000	VP400KH	115963	114300 015599-000	115732 024556-000	411424 019919-000	100431 093616-000	100430	102392 021740-000	100713 009384-000
4076-16	413014	VP400KH	413015	114300	413016	411424	100431	100430	102392 021740-000	100713
4076-17	413042	VP400KH	413237	114300	413238	411424	100431	100430	102392 021740-000	100713
4077	102289	VP400KH-MS	114268	102295	102290	412658	100523	100430	410690	100713
4078	410408 018718-000	VHP430KH-3	-	114300	102391	021714-000	100431	100430	102392 021740-000	100713
4078-1	410090	VHP430KH-3	410036	166260	410035	411424	100431	411430	102392 021740-000	100713
4078-5	410421	VHP430KH-3	410036	166260	116732	411424	100431	100430	102392 021740-000	100713
4078-6	020678-000	VHP430KH-3	-	015599-000	021747-000	019919-000	093616-000	-	021740-000	009384-000
4078-9	021937-000	VHP430KH-3	-	015599-000	022042-000	019919-000	093616-000	-	021740-000	009384-000
4078-10	022019-000	VHP430KH-3	-	015599-000	022023-000	019919-000	093616-000	-	021740-000	009384-000
4078-11	413347	VHP430KH-3	115963	114300	115732	411424	100431	100430	102392 021740-000	100713
4078-12	412263	VHP430KH-3SQ	412300	114300	161088	411424	100431	100430	160510	100713
4078-13	165797	VHP430KH-3	410778	114300	410764	411424	100431	100430	102392 021740-000	100713
4078-14	023167-000	VHP430KH-3	-	021003-000	023177-000	021714-000	093616-000	-	021740-000	009384-000
4078-16	413337	VHP430KH-3	412743	114300	412744	411424	100431	100430	102392 021740-000	100713
4078-18	413228 023694-000	VHP430KH-3	115963	114300 015599-000	115732 023695-000	411424	100431 015579-000	100392 022228-000	10239 021740-000	100713
4078-19	023694-000	VHP430KH-3	-	015599-000	023695-000	021714-000	093616-000	-	021740-000	009384-000
4078-21	413659	VHP430KH-3	413237	114300	413238	411424	100431	100430	102392 021740-000	100713
4079	166131	VHP370KA3	166262	166324	166232	411424	100431	100430	102392 021740-000	100713
4079-1	410138	VHP370KA3	410147	114300	410145	411124	100431	100430	102392 021740-000	100713
4079-6	413210	VHP370KA3	412743	114300	412744	411424	100431	100430	102392 021740-000	100713
4079-9	413034	VHP370KA3	413094	114300	413086	411424	100431	100430	102392 021740-000	100713
4080	100162	VO40KH	018301			412660	contact saft	contact saft	contact saft	-
4317CH1	025930-000	CVH430KA	-	015924-003	025929-000	019736-000	093616-000	-	022078-000	009384-000

ILLUSTRATED PARTS LIST

Battery	P/N reference	Cell	010 +020	010	020	200	210	220	230	240
4410CH1	416017	CVH441KH	112804			411344	100431	100430	116426	-
4417CH14	024904-000	CVH441KH	-	021003-000	024971-000	021714-000	093616-000	-	021740-000	009384-000
5512CH1	025654-000	CVH500KA	-	022043-000	025656-000	025656-000	093616-000	-	022012-000	093422-000
6206	412917	VP65K	411125			411684	411685		411667	
8050	100344	VO80KH	114831	106598	014459	-	-	-	-	-
12277-2	020413-000	VP120KHB	-	020425-000	021767-000	024731-000	093616-000	-	006631-026	009384-000
16106-1	167554	VP160KMSQ	410831	410830	410826	412230	-	-	-	-
16108-1	412826	VHP170KH-3SQ	410831	410830	410826	412230	-	-	-	-
16156-1	411103	VP160KH	411024	114300	102391	411301	100523	100430	411075	-
16158	411105	VHP170KH-3	411024			411301	100523	100430	411075	-
16256-3	023510-000	VP160KH								
16258	411431	VHP170KH-3	411266	410855	411449	411423	100523	100430	411422	-
23171-4	410530	VO23KH	410536	114318	410535	411425	100431	100430	102226	100713
23175	112972	VP230KH	114557	114318 015697-000	116767 021777-000	412642 020795-000	100431 093616-000	100430	102226 021741-000	100713 009384-000
23176	112695 016585-000	VP230KH	114557	114318 015697-000	116767 021777-000	412642 020795-000	100431 093616-000	100430	102226 021741-000	100713 009384-000
23378	410022	VHP260KH-3	410021	410020	161282	411335	165696	100430	102226	100713
23476	160786	VP230KH	161656	161637	161639	412646	165696	100430	102226	100713
23478	412811	VP230KH	161656	161637	161639	412646	165696	100430	102226	100713
23491	410426	VO23KH	415609	410436	415596	412647	100431	100430	102226	-
23491-3	410861	VO23KH	415609	410436	415596	412647	100431	100430	102226	-
23491-4	414915	VO23KH	414924	414925	414903	414916	100431	100430	102226	-
23498-1	413555	VHP260KH-3	415609	410436	415596	412647	100431	100430	102226	-
23576-1	018962-000	VP230KH	-	015697-000	021781-000	020795-000	093616-000	-	021741-000	009384-000
23678-1	411826	VHP260KH-3SQ	115917	114318	115731	411827	100431	100430	102226	100713
23678-2	412546	VHP260KH-3SQ	411792	114318	411791	411425	100431	100430	102226	100713
23678-3	413021	VHP260KH-3SQ	413074	114318	413077	411827	100431	100430	102226	100713
25106	116110	VP250KH	115591	115593	115592	412652	100431	100430	115947	-
25106-2	119708	VP250KH	115591	115593	115592	412652	100431	100430	115947	-
26108-3	414092	VHP260KH-3	414096	-	-	413471	-	-	-	-
26108-4	414136	VHP260KH-3	413892	-	-	413471	-	-	-	-
26108-5	414184	VHP260KH-3	413892	-	-	416200	-	-	-	-
26108-7	415243	VHP260KH-3	416322	-	-	416200	-	-	-	-
26308-1	413335	VHP260KH-3	413396	413387	413378	413397	100431	100430	102226	100713
26408-1	413384	VHP260KH-3	413438	413387	413434	413397	100431	100430	102226	100713
26508	414512	VHP260KH-3	414877	414876	414881	414535	-	-	414953	-
26608	414742	VHP260KH-3	414878	414876	414750	414535	-	-	414953	-
26708	414713	VHP260KH-3	414878	414876	414750	414535	-	-	414952	-
27278-2	411282	VHP270KH-3SQ	411287	114300	166459	411941	100431	100430	102392 021740-000	100713
27578-2	024470-000	VHP270KH-3	-	015599-000	024472-000		093616-000	-		
40042	411200	VOEC40KH	411322	411325		411297	100431	100430	411925	-

Battery	P/N reference	Cell	010 +020	010	020	200	210	220	230	240
40100A	410000	VO40KH	112804	113995	106516	411344	100431	100430	116426	-
40100-1	166768	VO40KH	112804	113995	106516	412654	100431	100430	116426	-
40100-2	414279	VHP430KH-3	112804	113995	106516	411344	100431	100430	116426	-
40152	100453	VO40KH	114520	100476	100455	412655	100431	100430	160510	100713
40180-2	414279	VHP430KH-3	112804	113995	106516	411344	100431	100430	116426	-1656-21
40142	411179	VOEC40KH	411322	-	-	411297	100431	100430	411925	-
40153	114628	VP400KH	114520	100476	100455	412655	100431	100430	102227	100713
40178	414219	VHP430KH-3	411171	411172	411111	411424	100431	100430	102392 021740-000	100713
40178-7	412586	VHP430KH-3	412600	412601	412589	412618	100431	100430	102392 021740-000	100713
40178-21	414377	VHP430KH-3	415433	415443	414521	411424	100431	100430	102392 021740-000	100713
40200	430801	VO40KH	165889	165888	166277	410995	160699	-	BAC102	-
40200-1	414690	VO40KH	414692	165888	414691	410995	160699	-	BAC102	-
40206-2	167468	VP400KH		165877	167543	410995	-	-	BAC102	-
40208	166185	VHP430KH-3	166265	166269	166266	410995	160699 101699	-	BAC102	-
40208-1	166409	VHP430KH-3	167523	165888	167522	410995	-	-	BAC102	-
40208-2	410089	VHP430KH-3	167523	165888	167522	410995	-	-	BAC102	-
40208-4	410677	VHP430KH-3	167523	165888	167543	410995	160699 101699	-	BAC102	-
40208-5	410687	VHP430KH-3	167523	165888	167543	411314	160699 101699	-	BAC102	-
40208-6	411978	VHP430KH-3	167523	165888	167522	410995	160699 101699	-	BAC102	-
40208-7	413095	VHP430KH-3SQ	167523	165888	167522	410995	-	-	BAC102	-
40209-2	410118	VHP370KA-3	167523	165888	167522		160699 101699	-	BAC102	-
40278-2	411289	VHP430KH-3SQ	115963	114300	115732	411424	100431	100430	102392 021740-000	100713
40278-14	415738	VHP430KH-3	412767	102295	412768	411424	100431	100430	413861	100713
40253	019654-000	VP340KA	021424-000			022041-000			022078-000	
40300	412473	VO40KH-3	412537	412536	412529	412535	116386	116387	BAC102	-
40306	166906	VP400KH-SQ	112804	113995	106516	412653	116386	116387	BAC102	-
40342	411652	VOEC40KH	411664	411663	411654	411665	100431	100430	411419	-
40371	411393	VOEC40KH	411420	411408	411372	411298	100431	100430	411419	-
40408	410422	VHP430KH-3	167523	165888	167522		160699 101699	-	BAC102	-
40508-1	413203	VHP430KH-3SQ	414224	414223	413177	413204	100431	100430	411715	-
40576	410860 023311-000	VP400KH-AC	411090 023313-000	411089	411076	411508 021442-000	100431 093616-000	100430 -	167174 022077-000	100713 009384-000
40576-3	017710-000	VP400KH-AC	-	018262-000	021792-000	-	093616-000	-	022077-000	009384-000
40576-14	023663-000	VP400KH	023664-000	018262-000	021793-000	021442-000	093616-000	-	022077-000	009384-000
40678-4	023450-000	VHP450KH-1	-	015599-000	023486-000	019919-000	093616-000	-	021740-000	009384-000
40776	023673-000	VP400KH-AC	023674-000			020581-000	093616-000	-	022077-000	009384-000
40778-11	413041	VHP430KH-3	413054	411405	413055	411428	100431	100430	102392 021740-000	100713

ILLUSTRATED PARTS LIST

Battery	P/N reference	Cell	010 +020	010	020	200	210	220	230	240
401076	019615-000	VP400KH-AC		018128-000	021797-000	021442-000	097197-000	091607-000	017689-000	009384-000
A275CH1	415808	CVH271KH-SQ	415815	415809	415811	416158	100431	100430	102226	415059
A407CH-3	413627	CVH400KH-SQ	413992	412479	413988	413714	100431	100430	102392 021740-000	100713
A2609-1	416266	VHP260KH-3-SQ	-	-	-	-	-	-	-	-
A4076-21	413605	VP-400KH-SQ	412300	114300	161088	411424	100431	100430	102392 021740-000	100713
A4078-12	412263	VHP430KH-3-SQ	412300	114300	161088	411424	100431	100430	102392 021740-000	100713
A26908	415509	VHP260KH-3-SQ	-	-	-	415665	-	-	-	-
A40209	166186	VHP370KH-3SQ	166265	166269	166266	411447	160699 101699	-	BAC102	-
A40209-1	413174	VHP370KH-3SQ	167523	165888	167522	410995	160699 101699	-	BAC102	-
B153CH1	415223	CVH150KH	415262	415268	415264	415346	108045	104960	415251	-
B1513CH1	415444	CVH150KH	415557	415268	415554	415564	108045	104960	415251	-
GB170	011360-000	KO7.5KH		018254-000	021825-000		092178-006	092724-000	018447-000	-

2-1. BAC102

Item	P/N	Description	Units
A	100708	Connector	1
B	165884	Connector base	1
C	165885	Gasket	1
D	165881	Terminal, positive	1
E	165882	Terminal, negative	1
F	165887	O-ring	2
G	011614	Nut, M22x1	2
H	011615	Nut, M18x1	2
I	160699	Screw, F/90, M4x8	3
J	101699	Screw, F/90, M4x12	1
K	102939	Protector	2

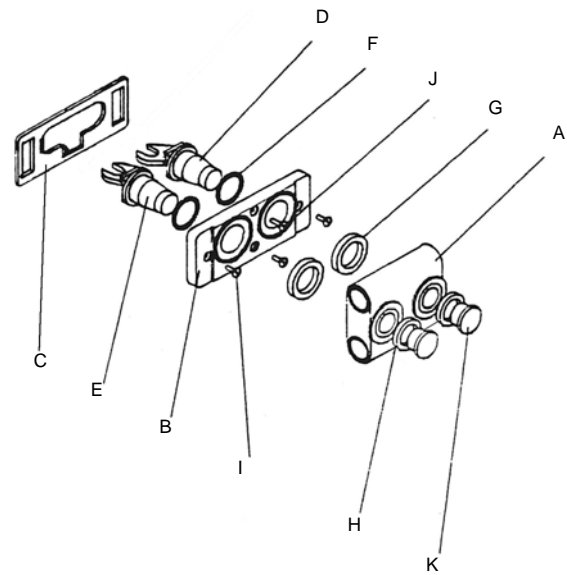

3. Links part list

3-1. List

Battery	Cell connections	030	040	050	060	070	080	090
19VO3KHB	VA1901	011949	-	-	-	-	-	-
20VO3KHB	VI2001	011949	414573	-	-	-	-	-
176CH	VA2001	015734-000	015735-000	015736-000	015737-000	019728-000	-	-
176CH6	VA2002	015737-000	015735-000	015736-000	015734-000	019728-000	016895-000	-
181CH	VG2002	101229	101228	-	-	-	-	-
272CH1	HD2001	012802	014403	114735	-	-	-	-
276CH7	VC2003	101229	100800	101228	101231	057012	101230	-
276CH10	VC2003	014403	012944	012943	014404	057012	014703	-
276CH23	VC2002	014403 015684-000	012944 021090-000	012943 015693-000	014404 015685-000	057012 015682-000	014703 015679-000	114735 015681-000
345CD1	HE2001	012943	013633	013678	014404	413419	415315	415316
405CH3	CA2005	012374	015539	116112	411691	114767	-	-
435CH6	CA2007	012374	411691	114767	015539	015266	-	-
438CH2	CA2002	015575-000	015577-000	015578-000	015576-000	015926-000	-	-
407CH5	CA2002	012374	015539	015266	411691	114767	-	-
407CH9	CA2002	015575-000	015577-000	015578-000	015926-000	015576-000	-	-
447CH1	CA2002	012374	015539	015266	057017	114767	-	-
505CH3	CA2005	414994	414993	114767	012374	012606	-	-
1277	CB1901	100516	100517	100518	100519	100520	102256	-
1277-1	CB1901	100516	100517	100518	118096	100520	102256	-
1277-3	CB1901	414142	414141	100518	414143	414144	414242	-
1600	VD2001	012943	014704	014702	-	-	-	-
1606	VD2002	013678	012943	-	-	-	-	-
1608	VD2002	013678	012943	-	-	-	-	-
1608-1	VD2003	013678	012943	114735	-	-	-	-
1656	VA2001	013678	012944	013633	012943	014703	-	-

ILLUSTRATED PARTS LIST

Battery	Cell connections	030	040	050	060	070	080	090
1656-1	VA2002	013678	012944	013633	012943	014703	114735	-
1656-2	VA2002	012943	012944	013633	013678	014703	-	-
1656-5	VA2002	012943	012944	013633	013678	014703	-	-
1658	VA2001	012943	012944	013633	013678	014703	-	-
1658-2	VA2002	012943	012944	013633	013678	014703	-	-
1666-1	VB2001	012943	014702	166878	114735	-	-	-
1718	VA1001	012943	414453	100874	013678	-	-	-
1756	VA2001	015734-000	015735-000	015736-000	015737-000	019728-000	-	-
2353-1	CB1902	101231	101229	101228	100890	057012	018043	018044
2371	CB2002	101228	101229	101230	101231	057012	100880	101230
2371-1	CB2001	101228	101229	101230	101231	057012	100880	114735
2371-2	CB2001	101228	101229	101230	101231	057012	100880	114735
2371-5	CB2001	101228	101229	101230	101231	057012	100880	114735
2371-6	CB2001	101228	101229	101230	101231	057012	100880	114735
2371-7	CB2003	101228	101229	101230	101231	057012	100880	-
2376	CB2002	101228	101229	101230	101231	057012	100880	101229
2376-1	CB2001	101228	101229	101230	101231	057012	100880	114735
2376-2	CB2001	101228	101229	101230	101231	057012	100880	114735
2376-4	CB2001	101228	101229	101230	101231	057012	100880	101228
2376-7	CB2002	101228	101229	101230	101231	057012	100880	-
2376-8	CB2001	101228	101229	101230	101231	057012	100880	114735
2378	CB2002	101228	101229	101230	101231	057012	100880	-
2500	VD2001	014709	103267	014702	-	-	-	-
2506-1	HB2001	013678	013955	115601	115598	-	-	-
2506-2	HB2002	013678	013955	115601	115598	116060	-	-
2522	VF2001	013955	103459	014702	014404	-	-	-
2708-1	HA2001	012374	165881	165882	-	-	-	-
2708-2	HA2002	012374	165881	165882	114767	-	-	-
2778	CA2001	012374	015539	015266	057014	-	-	-
2778-2	CA2002	012374	015539	116112	057014	114767	012374	-
2778-5	CA2002	012374	015539	166686	057014	166687	-	-
2778-10	CA2002	012374	015539	015266	057014	114767	-	-
2778-15	CA2002	012374	015539	116112	057014	114767	114767	-
2778-18	CA2001	012374	015539	015266	411691	-	-	-
4000A1	HA2001	012374	100079	100080	-	-	-	-
4002	HA2002	012374	100079	100080	-	-	-	-
4006A	HA2002	012374	100079	100080	-	-	-	-
4006A-1	HA2002	012374	100079	100080	-	-	-	-
4008-1	HA2003	012374	100079	100080	114767	-	-	-
4017CH-1	CA1901	015575-000	015577-000	015576-000	-	-	-	-
4050A1-1	CA2002	012374	100098	012521	057014	100097	014184	-
4071	CA2001	012374 015575-000	015539 015577-000	015266 015578-000	057014 015576-000	-	-	-
4071-1	CA2002	012374 015575-000	015539 015577-000	015266 015578-000	057014 015576-000	114767	-	-

Battery	Cell connections	030	040	050	060	070	080	090
4071-2	CA2002	012374 015575-000	015539 015577-000	116112 016423-000	057014 015576-000	114767 015576-000	-	-
4071-3	CA2002	012374 015575-000	015539 015577-000	116112 016423-000	057014 015576-000	114767 015576-000	-	-
4072	CA2001	012374 015575-000	015539 015577-000	015266 015578-000	057014 015576-000	-	-	-
4076	CA2001	012374 015575-000	015539 015577-000	015266 015578-000	057014 015576-000	-	-	-
4076-1	CA2002	012374 015575-000	015539 015577-000	015266 015578-000	057014 015576-000	114767 015576-000	012374 015575-000	-
4076-2	CA2002	012374 015575-000	015539 015577-000	015266 015578-000	057014 015576-000	114767 015576-000	-	-
4076-3	CA2002	012374 015575-000	015539 015577-000	015266 015578-000	057014 015576-000	114767 015576-000	-	-
4076-9	CA2002	012374	015539	015266	057014	114767	012374	-
4076-11	CA2001	015575-000	015577-000	015578-000	015576-000	-	-	-
4076-12	CA2001	015575-000	015577-000	015578-000	015576-000	-	-	-
4076-13	CA2001	015575-000	015577-000	015578-000	015576-000	-	-	-
4076-15	CA2002	012374 015575-000	015539 015577-000	116112 016423-000	057014 015576-000	114767 015576-000	-	-
4076-16	CA2002	012374	015539	015266	057014	114767	-	-
4076-17	CA2001	012374	015539	015266	411691	-	-	-
4077	CA1902	102298	102299	102300	102301	-	-	-
4078	CA2001	012374	015539	015266	057014	-	-	-
4078-1	CA2002	012374	015539	015266	057014	114767	-	-
4078-5	CA2002	012374	015539	116112	057014	114767	-	-
4078-6	CA2001	015575-000	015577-000	015578-000	015576-000	-	-	-
4078-9	CA2002	015575-000	015577-000	016423-000	015576-000	015926-000	-	-
4078-10	CA2002	015575-000	015577-000	015578-000	015576-000	015926-000	-	-
4078-11	CA2004	012374	015539	116112	411691	114767	413051	-
4078-12	CA2002	012374	015539	116112	057014	114767	012374	-
4078-13	CA2001	012374	015539	015266	057014	-	-	-
4078-14	CA2001	015575-000	015577-000	015578-000	015576-000	-	-	-
4078-16	CA2002	012374	015539	116112	411691	114767	-	-
4078-18	CA2002	012374	015539	116112	411691	114767	-	-
4078-19	CA2002	015575-000	015577-000	016423-000	015576-000	015926-000	015575-000	-
4079-19	CA2002	015575-000	015577-000	016423-000	015576-000	015926-000	-	-
4078-21	CA2001	012374	015539	015266	411691	-	-	-
4079	CA2001	012374	015536	015266	057014	-	-	-
4079-1	CA2002	012374	015539	015266	057214	102393	-	-
4079-6	CA2002	012374	015539	015266	411691	114767	-	-
4079-9	CA2001	012374	015539	015266	411691	-	-	-
4080	CA2001	014184	015539	012521	057014	012374	-	-
4317CH1	CA2002	015575-000	015577-000	016423-000	015576-000	015926-000	-	-
4417CH14	CA2001	015575-000	015577-000	015578-000	015576-000	-	-	-
4076-13	CA2001	015575-000	015577-000	015578-000	015576-000	-	-	-
5512CH1	VA1101	022002-000	022001-000	022003-000	-	-	-	-

ILLUSTRATED PARTS LIST

Battery	Cell connections	030	040	050	060	070	080	090
6206	VD2003	101279	-	-	-	-	-	-
12277-2	CB1901	017342-001	017342-002	017343-000	017342-003	017342-004	017342-003	-
16106-1	VD2003	013678	012943	114735	-	-	-	-
16108-1	VD2003	013678	012943	114735	-	-	-	-
16156-1	HC2001	012802	013678	014704	014404	012943	114735	-
16258	VA2002	013678	012944	013633	012943	014703	114735	-
23171-4	CB2002	101228	101229	101230	101231	057012	100880	-
23175	CB1903	101228	101229	101230	101231	057012	100880	114735 [95] 103489
23176	CB2001	101228 015681-00	101229 015685-000	101230 015679-000	101231 021090-000	057012 015684-000	100880	114735
23378	CB2002	101228	101229	101230	101231	057012	100880	-
23476	CB2001	101228	101229	101230	101231	057012	100880	114735
23478	CB2002	101228	101229	101230	101231	057012	100880	114735
23491	VC2001	101229	101230	101228	057012	105623	114735	-
23491-3	VC2001	101229	101230	101228	057012	105623	114735	-
23491-4	VC2001	057012	100880	101228	101229	101230	105623	413243
23498-1	VC2001	101229	101230	101228	057012	105623	114735	-
23576-1	CB2002	015676-000	015681-000	-	015683-000	015684-000	015685-000	015682-000
23676-2	VH2001	015681-000	015769-000	019277-000	019746-000	-	-	-
23678-1	CB2002	101228	101229	101230	101231	057012	100880	114735
23678-2	CB2002	101228	101229	101230	101231	057012	100880	-
23678-3	CB2001	101228	101229	101230	101231	057012	100880	114735
25106	HB2001	013678	013955	115601	115598	115948	115949	-
25106-2	HB2002	013678	013955	115601	115598	116060	115948	115949
26108-3	VG2001	101230	101228	413894	-	-	-	-
26108-4	VG2001	101230	101228	413894	-	-	-	-
26108-5	VG2001	101230	101228	413894	-	-	-	-
26108-7	VG2001	101230	101228	413894	-	-	-	-
26308-1		101228	101230	114735	100784	-	-	-
26408-1	VG2001	114735	101228	101229	-	-	-	-
26508	VG2002	101228	101229	414847	414848	-	-	-
26608	VG2002	101228	101229	414847	414848	-	-	-
26708	VG2002	101228	101229	414847	414848	-	-	-
27278-2	CA2002	012374	015539	116112	057014	114767	-	-
27578-2	CA2002	015575-000	015577-000	016423-000	015926-000	015575-000	-	-
40042	VA1001	015266	012606	012374	411017	015545	057014	-
40100A	HA2002	012374	116127	116428	-	-	-	-
40100-1	HA2002	012374	116427	116428	114767	-	-	-
40108-2	HA2002	012374	116427	116428	-	-	-	-
40142	VA1101	012374	015266	012606	411017	-	-	-
40143	VA1101	014184	012374	015539	057014	-	-	-
40152	VA1101	014184	012374	015539	057014	-	-	-
40178	CH2001	012374	057014	015539	015266	-	-	-
40178-7	CA2004	012374	412610	015539	412598	114767	412599	-

Battery	Cell connections	030	040	050	060	070	080	090
40178-21	CA2001	012374	015539	015266	411691	-	-	-
40200	HA2001	012374	-	-	-	-	-	-
40200-1	HA2004	012374	114767	-	-	-	-	-
40206-2	HA2002	012374	165881	165882	114767	-	-	-
40208	HA2001	012374	165881	165882	-	-	-	-
40208-1	HA2001	012374	165881	165882	-	-	-	-
40208-2	HA2002	012374	165881	165882	114767	-	-	-
40208-4	HA2002	012374	165881	165882	114767	-	-	-
40208-5	HA2004	012374	165881	165882	114767	-	-	-
40208-7	HA2004	012374	165881	165882	114767	-	-	-
40209-2	HA2001	012374	165881	165882	-	-	-	-
40253		015576-000	015575-000	015579-000	-	-	-	-
40278-2	CA2002	012374	015539	116112	057014	114767	-	-
40278-14	CA2001	012374	015539	015266	411691	-	-	-
40300	HA2002	012944	411999	412000	-	-	-	-
40306	HA2002	012374	100079	100080	-	-	-	-
40342	VA1002	012374	057014	012374	-	-	-	-
40371	CA2001	012374	015539	015266	057014	-	-	-
40408	HA2002	012374	165881	165882	114767	-	-	-
40508-1	VD2002	012374	108172	413187	-	-	-	-
40576	CA2001	012374 015575-000	015539 015577-000	015266 015578-000	057014 015576-000	-	-	-
40576-3	CA2001	015575-000	015577-000	015578-000	015576-000	-	-	-
40576-14	CA2001	015575-000	015577-000	015578-000	015576-000	-	-	-
40678-4	CA2002	015575-000	015577-000	023488-000	023489-000	015576-000	-	-
40776	CA2002	015575-000	015577-000	015578-000	015576-000	015926-000	-	-
40778-11	CA2004	012374	411691	015539	116112	114767	413051	-
401076	CA2002	015575-000	015577-000	015578-000	015576-000	015926-000	-	-
A275CH1	CA2006	416216	413983	014704	014703	014404	014403	90 : 012943 91 : 411730
A407CH-3	CA2002	015539	015539	116112	411691	012374	-	-
A2609-1	VD2003	012943	014403	413983	-	-	-	-
A4076-21	CA2002	012374	015539	116112	057014	114767	012374	-
A4078-12	CA2002	012374	015539	116112	057014	114767	-	-
A26908	VE2001	415569	415568	014403	012943	414917	-	-
A40209	HA2001	012374	165881	165882	-	-	-	-
A40209-1	HA2002	012374	165881	165882	114767	-	-	-
GB170	VA1902	007812-001	007812-003	-	-	-	-	-

Table 2 - Link parts list

ILLUSTRATED PARTS LIST

3-2. Drawings

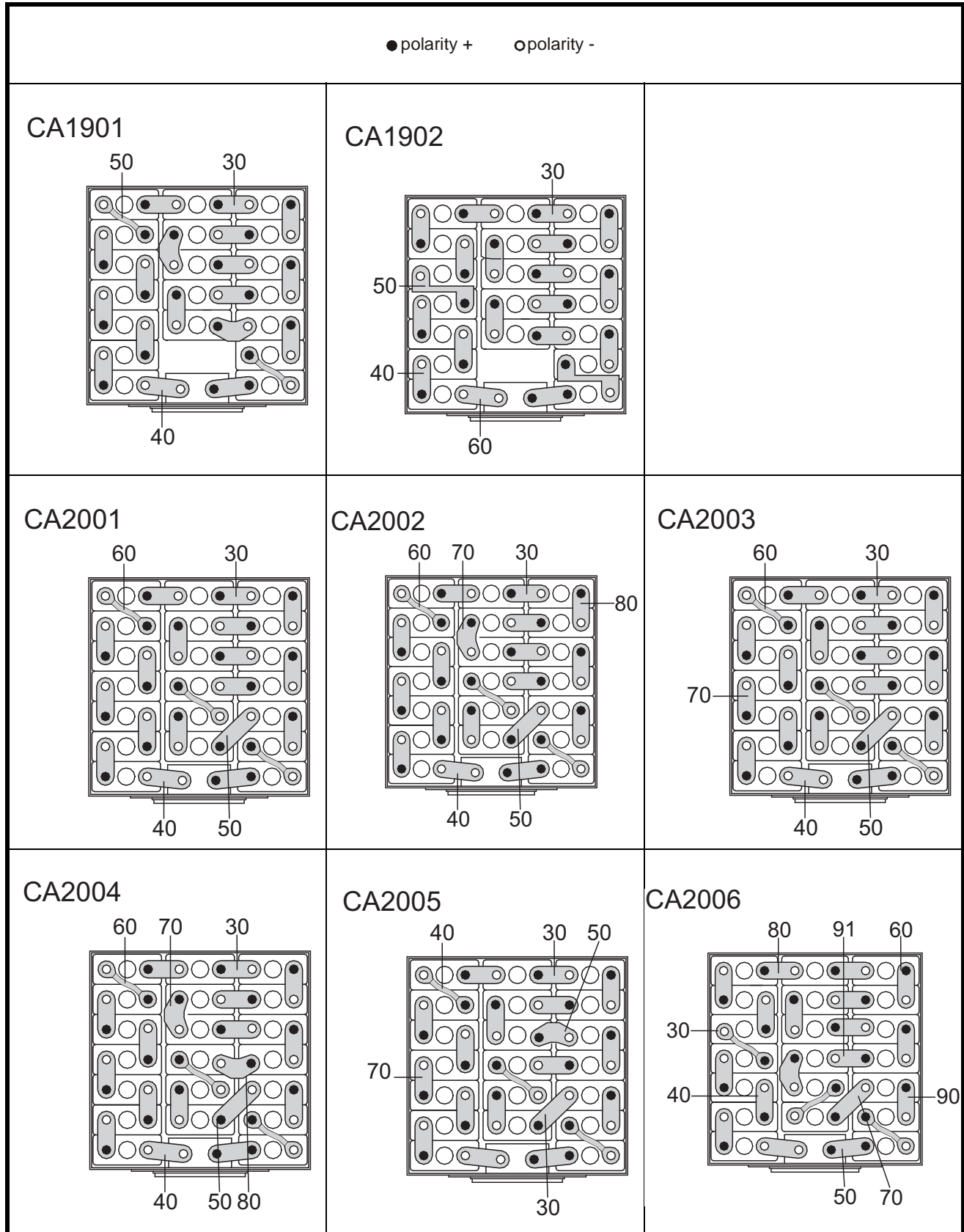

CA2007

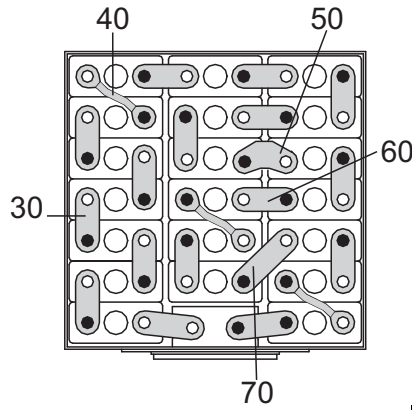

CB1901

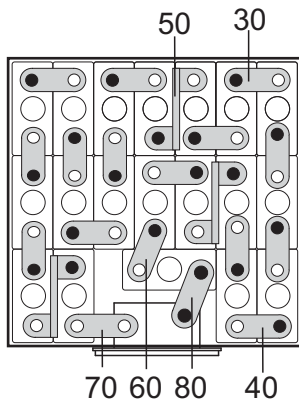

CB1902

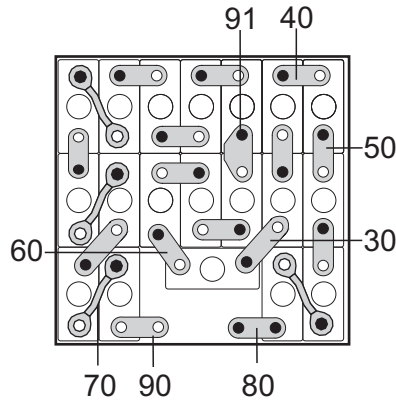

CB1903

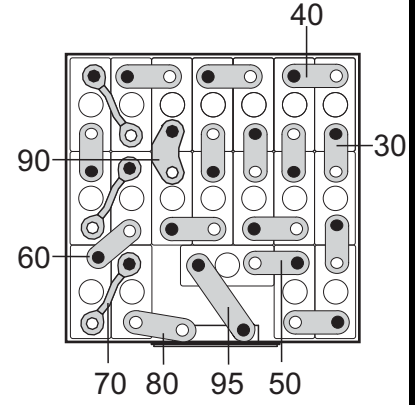

CB2001

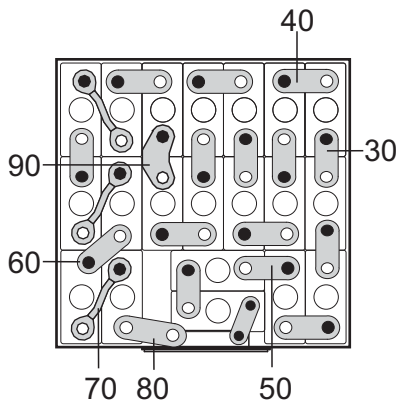

CB2002

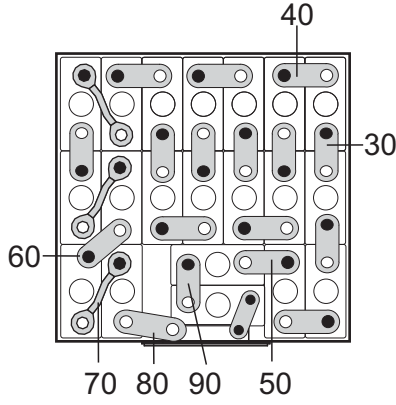

ILLUSTRATED PARTS LIST

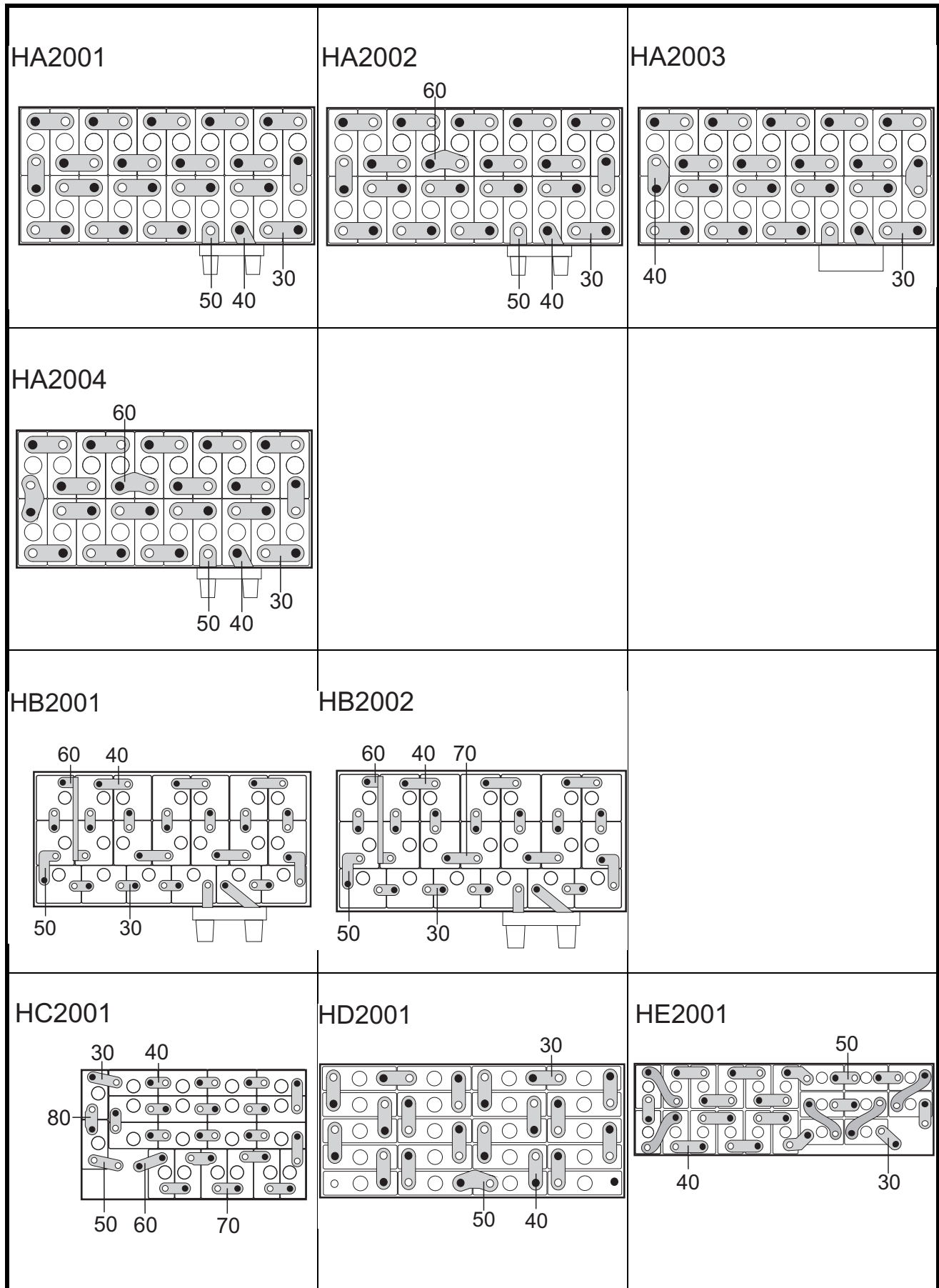

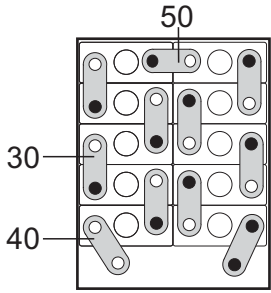
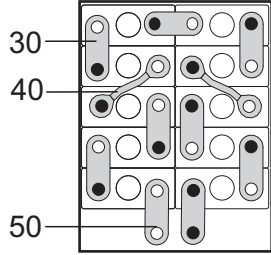
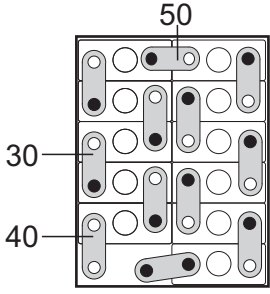
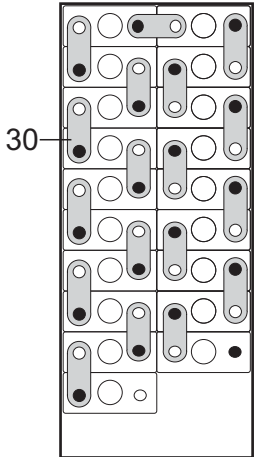
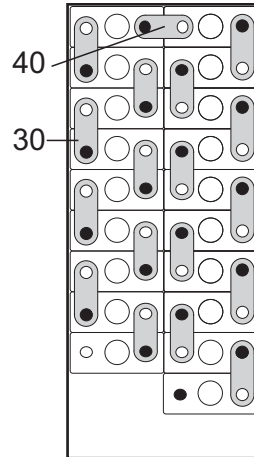
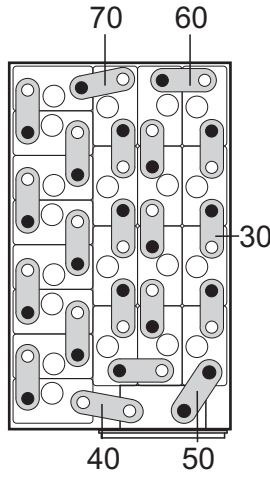
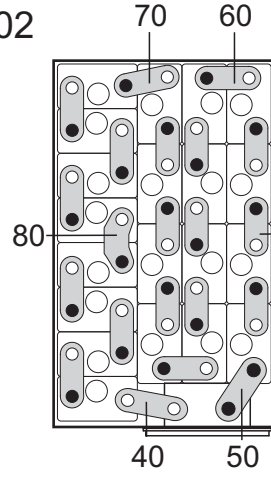
<p>VA1001</p> 	<p>VA1002</p> 	<p>VA1101</p> 
<p>VA1901</p> 	<p>VA1902</p> 	
<p>VA2001</p> 	<p>VA2002</p> 	

ILLUSTRATED PARTS LIST

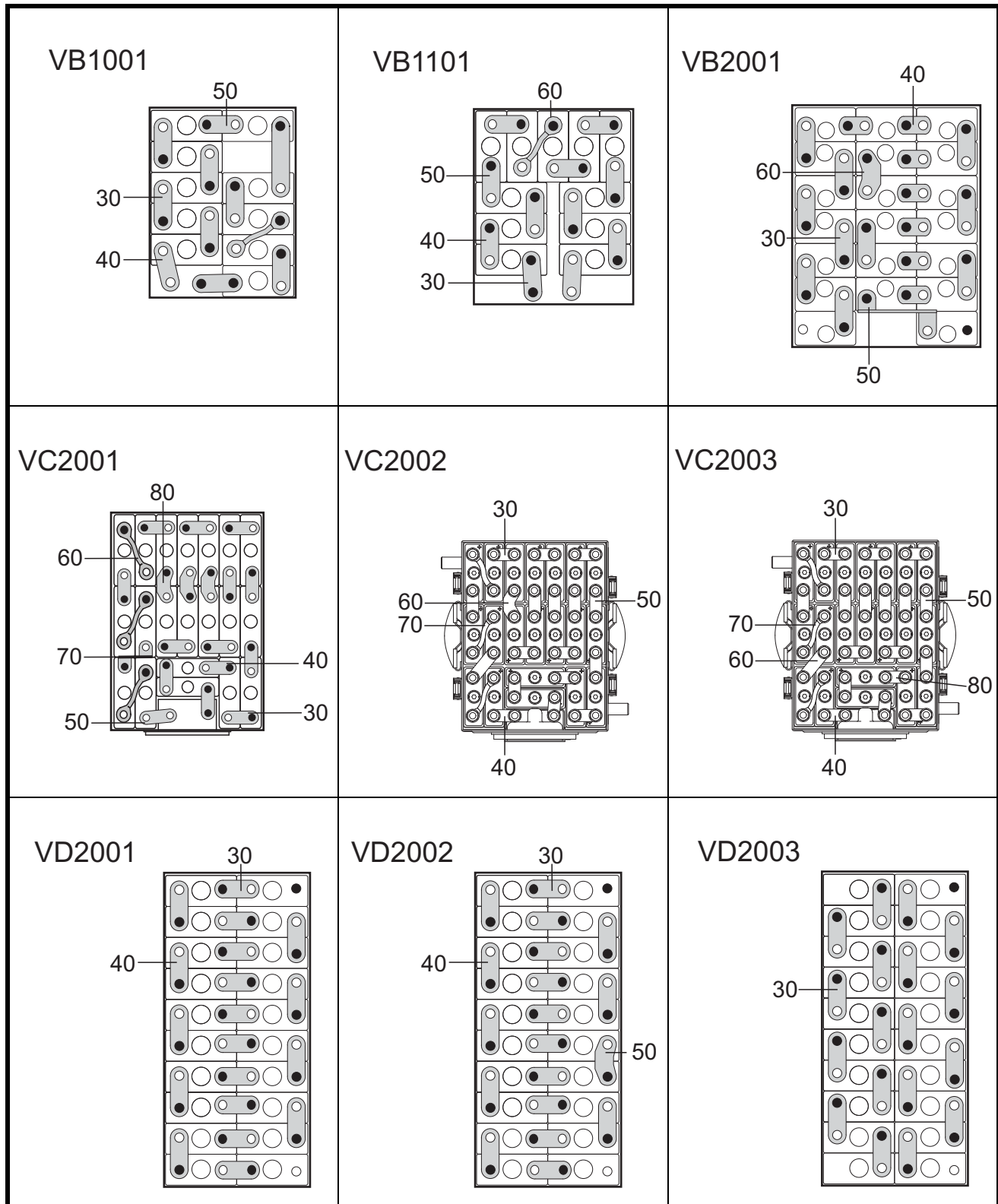

<p>VE2001</p> 	<p>VF2001</p> 	
<p>VG2001</p> 	<p>VG2002</p> 	<p>VH2001</p> 
<p>VI2001</p> 		

Table 3 - Drawings indicating proper placement of links and correct positioning of cell polarity

ILLUSTRATED PARTS LIST

4. Cell part list

Cell	100	110	120	130	140	150	160
CVD34KH	413481	413445	100111	100695	100696	100479	415219
CVH150KH	414400	411810 (upper) 413445 (lower)	100111	100695	100696	100479	415215
CVH170KA	025256-000	015995-000	018124-000	-	-	015999-000	023641-000
CVH180KH	414244	411810	100111	100695	100696	100479	415215
CVH180KH-SQ	413105	411810	100111	100695	100696	100479	415221
CVH271KH	415227	062000 015995-000	100111 018124-000	100695	100696	100479	415215
CVH271KH-SQ	415230	062000	100111	100695	100696	100479	415220
CVH400KA	413597	062007	100094	100694	100693	100078	413600
CVH400KH-SQ	413598	062007	100094	100694	100693	100078	413618
CVH430KA	025265-000	015579-000	022228-000	023388-001	023388-002	021870-000	023619-000
CVH441KH	414470	062007	100094	100694	100693	100078	415213 015957-000
CVH441KH-SQ	414491	062007	100094	100694	100693	100078	415217
CVH500KA	414984	062007	100094	100694	100693	100078	415213 015957-000
CVH531KA							
CVH550KA	025866-000	093707-000	092456-000	-	-	092488-000	023619-000
HVO1.1							
KO7.5KH	019872-000	090312-000	091179-014				
VHP170KH-3	166129	062000	100111	100695	100696	100479	415219
VHP170KH-3-SQ	412827	062023	100110	100695	100696	100479	415220
VHP230KA3	410406	062007	100094	100694	-	100078	415218
VHP260KH-3	166300	062000	100111	100695	100696	100479	415219
VHP260KH-3-SQ	410232						
VHP270KH-3	165949	062007	100094	100694	100693	100078	415218
VHP270KH-3-SQ	410155	062007	100094	100694	100693	100078	415217
VHP370KA-3	165823	062007	100094	100694	100693	100078	415218
VHP370KH-3-SQ	166127	062007	100094	100694	100693	100078	415217
VHP430KH-3	165797 019858-000	062007 015579-000	100094 022228-000	100694 023388-001	100693 023388-002	100078 021870-000	415218 023400-000
VHP430KH-3SQ	411288	062007	100094	100694	100693	100078	415217
VHP450KA-3	411480	062007	100094	100694	100693	100078	415213 015957-000
VHP450KH-1	023065-000	015579-000	021871-000	023388-001	023388-002	02870-000	015957-000
VO3KHB	102875	062005	100132	102158	102159	-	102880 + 100656
VO16KH	063409	062000	100111	100973	013998	013999	415215
VO23KH	063410	062000	100111	100695	100696	100479	415215
VO23KH-SQ	410537	062000	100111	100695	100696	100479	415220
VO25KA	103247	062000	100111	100695	100696	100479	415215
VO25KA-C	412948	062000	100111	100695	-	100479	415215
VO40KH	063428 016650-000	062007 015579-000	100094 02228-000	100694 023388-001	100693 023388-002	100078 021870-000	415213 015957-000
VO40KH-3	412462	062023	100111	100695	100696	100479	

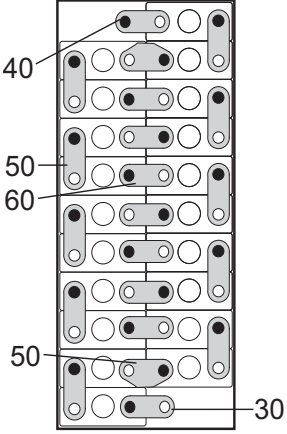
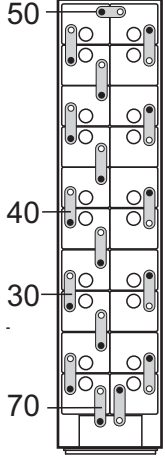
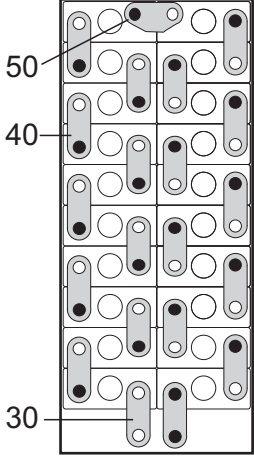
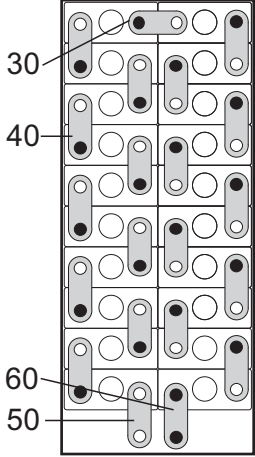
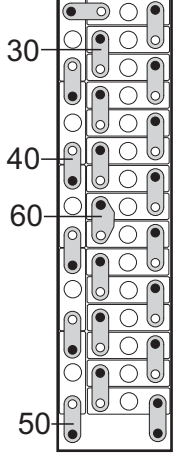
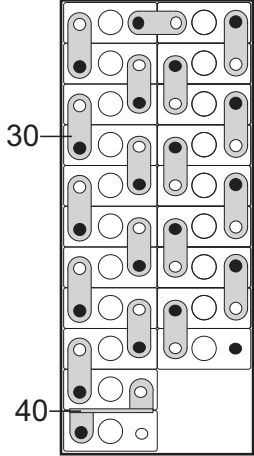
Cell	100	110	120	130	140	150	160
VO40KH-C	412933	062007	100094	100694	100693	100078	415213 015957-000
VO80KH	102555	062013	011649	100325	100326	412269	
VOEC40KH	411366	411362	100094	100694	-	100078	
VP120KHB	018910-000	009772-000	091179-035	-	-	008021-002	093625-000
VP120KH-MS	063424		102883	-	-	-	
VP160KH	063417	062023	100111	100695	100696	100479	
VP160KH-SQ	410379	062000	100111				415220
VP160KM	161144	062003	100111	100695	100696	100479	415215
VP160KM-SQ	167590	062003	100111	100695	100696	100479	415220
VP170KH	163937	062002	100111	100695	100696	100479	415215
VP200KHB	459842	062000	100111	100695	100696	100479	415220
VP230KH	063415 015698-000	062000 015995-000	100111 018124-000	023935-001	023935-002	100479 015999-000	415215 015990-000
VP250KH	063413	062023	100111	100695	100696	100479	415215
VP340KA	021684-000	015579-000	022228-000	-	-	-	415213 015957-000
VP380KH	021685-000	015579-000	022228-000	-	-	-	415213 015957-000
VP400KH	063412 015602-000	062007 015579-000	100094 022228-000	100694 023388-001	100693 023388-002	100078 021870-000	415213 015957-000
VP400KH-AC	017360-000	015579-000	022228-000				017621-000
VP400KH-MS	410583	083003	078011	-	-	-	
VP400KH-SQ	166927	062007	100111	100694	100693	100094	415217
VP430KH-3	019958-000	015579-000	022228-000	023388-001	023388-002	021870-000	023400-000
VP65K	100742	100736	100111	-	-	100735	415214
VXP310KH	412960	062007	100094	100694	-	100094	415218

Table 4 - Cell parts list

STORAGE (INCLUDING TRANSPORTATION)

1. Introduction

1-1. General

Storage preparation and packaging makes sure that the equipment is protected against any attack by atmospheric agents.

The figure and item numbers are those of the [ILLUSTRATED PARTS LIST](#) chapter.

1-2. Storage room

Keep the batteries and spares in a dry and clean room.

1-3. Temperature conditions

The recommended temperature range is + 20 °C ±15 °C (68 °F ±27 °F). However, occasional excursion into the range of -60 °C to +60 °C (-76 °F to +140 °F) is permitted.

2. Inactive long term storage

NOTE: No maintenance operation needs to be performed during the storage period

The battery should be stored filled and discharged. It is not necessary that it be short circuited.

The storage life is 10 years, if using the following conditions :

- Sealed packaging.
- Temperature: + 20 °C ± 15 °C (68 °F ± 27 °F).
- Humidity: < 70 %.
- Normal vertical position.
- Isolated from detrimental agents: dirt, dust, humidity, vibration, corrosive atmosphere.

Lead batteries must not be stored in the same room.

Saft Ni-Cd batteries may be stored in temperatures ranging from -55 °C (-67 °F) to +60 °C (+140 °F) for short periods of time without harming the battery.

The standard cardboard packaging is considered unsealed and allows 2 years of storage under the above conditions.

3. Inactive stand-by storage

Definition: the battery is charged after being serviced then stored fully charged in a dedicated room in such a way that it can be installed in the A/C without further check. Charge retention depends on the ambient temperature in which the battery is stored and the duration of the storage .

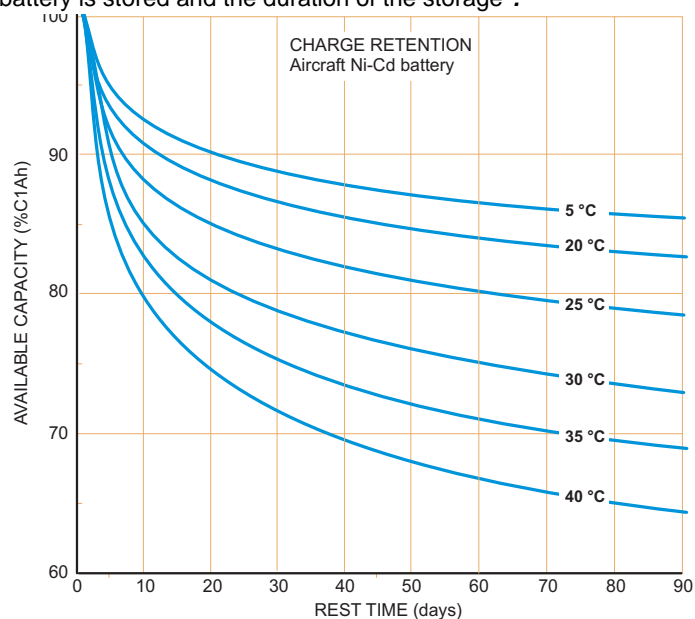

Figure 115001 Short term storage

Storage (including transportation)

3-1. Ambient temperature lower than or equal to 20 °C (68 °F)

The battery may be kept in stand-by for up to 90 days (state of charge reduction < 20% C1Ah).

3-2. Ambient temperature greater than 20 °C (68 °F)

The battery may be kept in stand-by for the period corresponding to 80% available capacity on the attached chart (for example 24 days at +30°C).

3-3. Extending the inactive stand-by with 'topping' or 'refresh charge'

NOTE: The time necessary to reach the required voltage should be very short.

NOTE: The four (4) hours overcharge at 0.1 C1A (refer to PARA Charge) should not be performed during this " refresh " charge operation.

The stand-by period defined in §3.2 can be prolonged by applying a " topping " or " refresh " charge, at the end of the period. The charge is defined as a short charge at 0.1 C1A, 0.5 C1A or 1 C1A until the voltage reaches the values given in the table below:

CHARGE rate	VOLTAGE (end of " refresh " charge)
0.1 C ₁ A	30 V for 20 cells
0.5 C ₁ A	31 V for 20 cells
1 C ₁ A	31.4 V for 20 cells

Table 1:

The battery can be 'refreshed' up to two (2) times (for example 24 days at +30°C can be prolonged to 72 days at +30°C).

3-4. Action at the end of the stand-by period

⚠ If the above conditions are not met, there is a risk of placing a battery on board the aircraft that does not meet the emergency requirements.

At the end of the stand-by period defined in the above paragraphs, if the battery is not immediately installed in the aircraft, it must be subject to one of the following procedures:

- If the battery has been subject to one period, or two successive periods of stand-by, it must be discharged and recharged (refer to [Periodical check](#)) after which it can be subject to another period of up to 3 months stand-by. If it is to be put into long term storage refer to PARA Inactive long term storage.
- If the battery has been subject to three successive periods of stand-by, it must undergo electrical treatment (refer to [Regular check](#)) after which it can be subject to another sequence of three stand-by periods of up to 3 months. If it is to be put into long term storage refer to PARA Inactive long term storage.
- If the battery has previously been stored at a temperature below that of the ambient, condensation may occur: before installing, verify the insulation resistance.

4. Active stand-by mode (= use of a trickle charge)

⚠ water consumption.

Principle : the battery is continuously charged, in an overcharge condition.

Saft does not recommend this method, however some operators take responsibility for its use. This method is not reliable due to quantity and inaccuracy of water consumption. Example: if a 40 Ah battery remains on a continuous trickle charge of 3 mA/Ah for one month, the total consumption of water is 35 cm³/cell. The operator must adjust the electrolyte level before placing the battery onboard the aircraft. Otherwise the risk of a battery incident exists: cells dried out before the normal end of the interval maintenance. This creates the conditions for a thermal runaway with all its consequences (unscheduled removal with the possibility of the total loss of the battery and a delayed if not cancelled flight).

5. Spares

5-1. Spare Cells

Spare cells must be stored discharged. It is not necessary that they be short circuited. The vent valves must not be removed. The storage conditions are the same as those given in §2. No maintenance operation is needed during storage. Before installation in a battery, cells must be visually inspected for damage or leakage and cleaned and repaired as necessary in accordance with the battery maintenance documentation.

5-2. Spare O-rings, gaskets and vent valves

O-rings should be stored in sealed containers (non-PVC) and protected from exposure to air, light and high humidity (>70 %). Storage life depends on temperature so it is recommended to store O-rings in a cool area (<25 °C (77 °F)). Under these conditions storage life is up to 10 years from date of manufacture. At +35 °C (95 °F), storage life is 5 years. Vent valves that are equipped with O-rings are subject to the same storage conditions.

Before use, O-rings must be inspected and any showing visible signs of damage, distortion or deterioration must be discarded.

5-3. Other spares

Other spares, protected from external contamination and high humidity (>70 %), may be stored for unlimited periods. Before use, they must be inspected and any showing visible signs of damage, distortion or deterioration must be discarded.

6. Servicing after discharged storage

Storage time	Servicing procedure
Less than 3 months	Visual Inspection Insulation check Nut tightness charge Adjust electrolyte level
3 months to 1 year	Charge followed by Periodical check
More than 1 year	Charge followed by Regular check .

7. Transportation procedure

The battery is normally discharged before packing. If it is necessary to transport a charged battery, make sure that the output terminals are protected against short circuit.

The battery should then be packed vertically in its original container. If the original container is not available, the international and/or local packaging regulations applicable to the mode of transport and destination must be followed.

According to the IATA / IMDG dangerous goods regulations, Saft ships all existing nickel-cadmium batteries or cells for aircraft under the classification UN2795 (wet, filled with alkali) according to packing instruction 800.

PAGE INTENTIONALLY LEFT BLANK